

Woods Hole Oceanographic Institution



Stratus Ocean Reference Station (20°S, 85°W)

Mooring Recovery and Deployment Cruise
R/V Ronald H. Brown Cruise 05-05,
September 26, 2005–October 21, 2005

by

Lara Hutto¹
Robert Weller¹
Jeff Lord¹
Jason Smith¹
Paul Bouchard¹
Chris Fairall²
Sergio Pezoa²
Ludovic Bariteau³
Jessica Lundquist³
Virendra Ghate⁴
Rodrigo Castro⁵
Carolina Cisternas⁵

¹Woods Hole Oceanographic Institution, ²NOAA Environmental Technology Laboratory,
³University of Colorado, CIRES, ⁴University of Miami, ⁵University of Concepcion

February 2006

Technical Report

Funding was provided by the National Oceanic and Atmospheric Administration
under Grant No. NA17RJ1223 and the Cooperative Institute for Climate and Ocean Research (CICOR).

Approved for public release; distribution unlimited.



Upper Ocean Processes Group
Woods Hole Oceanographic Institution
Woods Hole, MA 02543
UOP Technical Report 2006-01

WHOI-2006-06
UOP-2006-01

Stratus Ocean Reference Station (20°S, 85°W)

Mooring Recovery and Deployment Cruise
R/V Ronald H. Brown Cruise 05-05,
September 26, 2005–October 21, 2005

by

Lara Hutto¹
Robert Weller¹
Jeff Lord¹
Jason Smith¹
Paul Bouchard¹
Chris Fairall²
Sergio Pezoa²
Ludovic Bariteau³
Jessica Lundquist³
Virendra Ghate⁴
Rodrigo Castro⁵
Carolina Cisternas⁵

¹Woods Hole Oceanographic Institution, ²NOAA Environmental Technology Laboratory,
³University of Colorado, CIRES, ⁴University of Miami, ⁵University of Concepcion

February 2006

Technical Report

Funding was provided by the National Oceanic and Atmospheric Administration under Grant No. NA17RJ1223 and the Cooperative Institute for Climate and Ocean Research (CICOR).

Reproduction in whole or in part is permitted for any purpose of the United States Government.
This report should be cited as Woods Hole Oceanog. Inst. Tech. Rept., WHOI-2006-06.

Approved for public release; distribution unlimited.

Approved for Distribution:

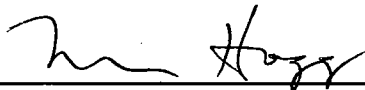

Nelson G. Hogg, Chair

Department of Physical Oceanography

ABSTRACT

The Ocean Reference Station at 20°S, 85°W under the stratus clouds west of northern Chile is being maintained to provide ongoing, climate-quality records of surface meteorology, of air-sea fluxes of heat, freshwater, and momentum, and of upper ocean temperature, salinity, and velocity variability. The Stratus Ocean Reference Station (ORS Stratus) is supported by the National Oceanic and Atmospheric Administration's (NOAA) Climate Observation Program. It is recovered and redeployed annually, with cruises that have come between October and December.

During the October 2005 cruise of NOAA's R/V *Ronald H. Brown* to the ORS Stratus site, the primary activities were recovery of the WHOI surface mooring that had been deployed in December 2004, deployment of a new WHOI surface mooring at that site, in-situ calibration of the buoy meteorological sensors by comparison with instrumentation put on board by staff of the NOAA Environmental Technology Laboratory (ETL), and observations of the stratus clouds and lower atmosphere by NOAA ETL.

The ORS Stratus buoys are equipped with two Improved Meteorological (IMET) systems, which provide surface wind speed and direction, air temperature, relative humidity, barometric pressure, incoming shortwave radiation, incoming longwave radiation, precipitation rate, and sea surface temperature. The IMET data are made available in near real time using satellite telemetry. The mooring line carries instruments to measure ocean salinity, temperature, and currents. The ETL instrumentation used during the 2005 cruise included cloud radar, radiosonde balloons, and sensors for mean and turbulent surface meteorology.

In addition, two technicians from the University of Concepcion collected water samples for chemical analysis. Finally, the cruise hosted a teacher participating in NOAA's Teacher at Sea Program.

This Page Left Intentionally Blank.

TABLE OF CONTENTS

ABSTRACT.....	II
TABLE OF CONTENTS	IV
LIST OF FIGURES.....	VI
LIST OF TABLES.....	IX
ABBREVIATIONS.....	IX
I. PROJECT BACKGROUND AND PURPOSE.....	1
II. STRATUS 2005 CRUISE.....	3
A. OVERVIEW.....	3
B. PRE-CRUISE AND CRUISE DETAILS.....	5
III. ORS STRATUS MOORINGS.....	9
A. OVERVIEW.....	9
B. SURFACE INSTRUMENTS	9
1. <i>Improved Meteorological (IMET) Systems</i>	9
C. SUBSURFACE INSTRUMENTS	10
1. <i>Floating SST Sensor</i>	11
2. <i>Subsurface Argos Transmitter</i>	11
3. <i>SeaCat Conductivity and Temperature Recorders</i>	11
4. <i>MicroCat Conductivity and Temperature Recorder</i>	11
5. <i>Brancker Temperature Recorders (TPOD)</i>	11
6. <i>Brancker XR-420 Temperature and Conductivity Recorder</i>	11
7. <i>SBE-39 Temperature Recorder</i>	12
8. <i>Vector Measuring Current Meters (VMCMs)</i>	12
9. <i>Aanderaa Current Meter (Stratus 5 only)</i>	12
10. <i>RDI Acoustic Doppler Current Profiler</i>	12
11. <i>SonTek Argonaut MD Current Meter</i>	12
12. <i>Nortek</i>	12
13. <i>Acoustic Release</i>	12
D. STRATUS 5 RECOVERY	13
1. <i>Mooring Description</i>	13
2. <i>Recovery Process</i>	17
3. <i>Time Spikes</i>	18
4. <i>Stratus 5 Instrument Performance</i>	20
5. <i>Antifoulant performance</i>	20
E. STRATUS 6 DEPLOYMENT	23
1. <i>Mooring Description</i>	23
2. <i>Time Spikes</i>	27
3. <i>Antifoulant Application</i>	29
4. <i>Deployment Process</i>	30
5. <i>Site of the Stratus 6 Surface Mooring</i>	35
IV. ETL MEASUREMENTS.....	40
A. BACKGROUND ON MEASUREMENT SYSTEMS.....	40
B. SELECTED SAMPLES	41
1. <i>Flux Data</i>	41
2. <i>Remote Sensing Data</i>	42

C. CRUISE SUMMARY RESULTS.....	43
1. <i>Basic Time Series</i>	43
2. <i>Boundary Layer and Cloud Properties</i>	44
D. INTERCOMPARISONS	44
1. <i>ETL-Ship Comparisons</i>	45
2. <i>Psychrometer Comparisons</i>	45
E. ETL DATA CRUISE ARCHIVE	46
1. <i>Data Archive Directories</i>	46
V. INSTRUMENT INTERCOMPARISONS	64
A. CTD CASTS	64
B. SHIP TO BUOY IMET COMPARISONS.	67
C. ETL TO BUOY COMPARISONS.....	72
VI. ADDITIONAL CRUISE ACTIVITIES.....	73
A. DEPLOYMENT OF DRIFTERS AND UNDERWAY WATCH.....	73
B. UNIVERSITY OF CONCEPCION RESEARCH	74
C. TEACHER-AT-SEA PROGRAM.....	76
ACKNOWLEDGEMENTS	77
APPENDIX A – CRUISE LOGISTICS	78
APPENDIX B – MOORING LOGS.....	79
APPENDIX C – BUOY SPINS	95
APPENDIX D – INSTRUMENT NOTES.....	116
APPENDIX E - IMET SETUP NOTES.....	121

LIST OF FIGURES

Figure 1: The Stratus 2005 cruise track, showing the Stratus mooring, and approximate locations of drifter and float deployments.	5
Figure 2. Stratus 5 mooring diagram.	14
Figure 3: The Stratus 6 mooring diagram	26
Figure 4. Map showing track plan for Stratus 6 deployment.....	31
Figure 5. Track line for the SeaBeam survey to locate the site for deployment of Stratus 6.	35
Figure 6. Planned deployment track in black, with ships actual track in green.....	37
Figure 7. The three survey positions with slant range arcs generated by Survey.	38
Figure 8. The anchor position determined by Survey, 20° 02.67034’S, 85° 11.30540’W.	38
Figure 9. The horizontal range arcs and anchor position (20° 2.6738’S, 85° 11.2975’W) determined using Ccours.....	39
Figure 10. Cruise track for RBH on October 13 (DOY 286). The x marks the WHOI buoy location; the diamond is the DART buoy.	47
Figure 11. Time series of near-surface ocean temperature (green) and 15-m air temperature (blue).....	47
Figure 12. True wind direction from the ETL sonic anemometer (18 m) and the IMET propvane (15 m).....	48
Figure 13. True wind speed from the ETL sonic anemometer (18 m) and the ship’s propvane (15 m).....	48
Figure 14. Time series of downward solar flux from ETL and ship Eppley sensors. The green line is a model of the expected clear sky value.	49
Figure 15. Time series of downward IR flux from ETL and ship Eppley sensors. The red line is a model of the expected clear sky value.....	49
Figure 16. Time series of non-solar surface heat flux components: sensible (blue), latent (green), and net IR (red).....	50
Figure 17. Time series of net heat flux to the ocean surface. The values at the top of the graph are the average for the day for each component of the flux.....	50
Figure 18. Cloud-base height information extracted from the ceilometer backscatter data for day 287 (October 14, 2005).....	51
Figure 19. Time-height cross section data from 9.4 GHz cloud radar data for day 287 (October 14, 2005): upper panel, backscatter intensity; middle panel, mean Doppler vertical velocity; lower panel, Doppler width. The deep vertical streaks are drizzle.	52
Figure 20. Time series of data from both the <i>new</i> and the <i>old</i> Radiometrics microwave radiometers: upper panel – column water vapor, lower panel – column water liquid. Note, new radiometer liquid water was divided by 10.	53
Figure 21. Sample wave time series from 1000 UTC on day 286 (October 13) from the laser rangefinder. The trace shows elevation of the sea surface relative to the bow of the ship. The dominant wave period is about 6 seconds.	53
Figure 22. Wind speed and direction comparison of the wind profiler and the rawinsonde launched 18 Z October 6, 2005.....	54
Figure 23. Cruise track for entire Stratus 2005 cruise.	54

Figure 24. Time series of near-surface ocean temperature (blue) and 15-m air temperature (green) for the 2005 RHB Stratus cruise.....	55
Figure 25. Time series of wind speed (upper panel), northerly component (middle panel), and easterly component (lower panel) for the 2005 RHB Stratus cruise.....	55
Figure 26. Diurnal average of northerly and easterly wind components for period near 20° S, 85° W.....	56
Figure 27. Time series of 24-hr average heat flux components: solar flux - circles; latent heat flux - triangles; sensible heat flux - diamonds; net IR flux x's.....	56
Figure 28. Time series of daily averaged radiative cloud forcing: IR CF (Wm ⁻²) – green, Solar CF (Wm ⁻²) – blue.....	57
Figure 29. Selected variables from the N-S transect along 85° W. Upper panel is wind speed; the middle panel is sea surface temperature (blue) and air temperature (green); the lower panel shows sensible (blue) and latent (green) heat fluxes.....	57
Figure 30. Same as Figure 20, but for the W-E transect along 20° S from 85° W to 70° W.....	58
Figure 31. Aerosol concentrations from Lasair-II spectrometer. Upper panel: total number concentration for aerosols larger than 0.1 micron diameter. Lower panel: aerosol concentrations for 0.1-0.2 (blue), 0.2-0.3 (green), 0.3-0.5 (red), 0.5-1.0 (cyan), and 1.0-5.0 (magenta). Spikes are caused by the ship's exhaust.....	58
Figure 32. Time-height color contour plots from rawinsondes launched during the 2005 stratus cruise. The upper panel is temperature; the lower panel is relative humidity.....	59
Figure 33. Time-height color contour plots from rawinsondes launched during the 2005 Stratus cruise. The upper panel is wind speed; the lower panel is wind direction.....	60
Figure 34. Time-height color contour plots of potential temperature from rawinsondes launched during the 2005 Stratus cruise. This height scale emphasizes the atmospheric boundary layer.....	61
Figure 35. Time series of low cloud-base heights for the experimental period during October.....	61
Figure 36. Time series of microwave radiometer-derived values for column integrated water vapor (upper panel) and column integrated liquid water (lower panel). Old mailbox=green, new mailbox=blue, and integrals from rawinsondes profiles=red x's (upper panel only).....	62
Figure 37. Comparison of simultaneous Assman psychrometer (x's) and ship (circles) readings for air temperature. Psychrometer values corrected to 15 m (ETL and ship instrument height).....	62
Figure 38. Comparison of simultaneous Assman psychrometer (x's) and ship (circles) readings for specific humidity. Psychrometer values corrected to 15 m (ETL and ship instrument height).....	63
Figure 39. CTD cast 1 results. Red line is temperature; blue line is salinity.....	65
Figure 40. CTD cast 2 results. Red line is temperature; blue line is salinity.....	65
Figure 41. CTD cast 3 results. Red line is temperature; blue line is salinity.....	66
Figure 42. CTD cast 4 results. Red line is temperature; blue line is salinity.....	66

Figure 43. Ship-buoy air temperature comparison. S5 and S6 denote Stratus 5 and 6 respectively. Likewise, L# denotes the IMET logger number on each mooring. The following figures follow the same labeling scheme.....	67
Figure 44. Ship-buoy barometric pressure comparison	68
Figure 45. Ship-buoy relative humidity comparison.....	68
Figure 46. Ship-buoy air temperature comparison.....	69
Figure 47. Ship-buoy air temperature comparison.....	69
Figure 48. Ship-buoy sea surface temperature comparison	70
Figure 49. Ship-buoy shortwave radiation comparison	70
Figure 50. Ship-buoy wind comparison	71
Figure 51. Comparison of ETL, Stratus 5, and Stratus 6 longwave radiometers.....	72

LIST OF TABLES

Table 1: Type of measurements taken by the Stratus moorings.	2
Table 2: Stratus 2005 science party	3
Table 3: Stratus 2005 ship's crew.....	4
Table 4: Stratus 5 deployment and recovery overview	13
Table 5: Stratus 5 surface instrumentation.....	15
Table 6: Stratus 5 subsurface instrumentation	16
Table 7: Stratus 5 pre-deployment timing spikes.....	19
Table 8: Stratus 5 Post-Recovery Spikes	19
Table 9. NGVM Post-recovery rotor spins	20
Table 10. Stratus 5 antifoulant applications.....	22
Table 11: Stratus 6 deployment details.....	23
Table 12: Stratus 6 surface buoy instrumentation.....	24
Table 13: Stratus 6 subsurface instrumentation	25
Table 14. Stratus 6 pre-deployment timing spikes.....	27
Table 15: Stratus 6 antifoulant application details.....	30
Table 16. Anchor position survey details.....	37
Table 17: Stratus 2004 cruise CTD depths, times and locations	64
Table 18: Deployment times and locations for the Argo floats	73
Table 19: Deployment times and locations for the surface drifters	74
Table 20. Location of water sampling stations.	75

ABBREVIATIONS

ADCP	Acoustic Doppler Current Meter
CTD	Conductivity Temperature Depth
EPIC	Eastern Pacific Investigation of Climate
ETL	NOAA Environmental Technology Laboratory
GPS	Global Positioning System
IMET	Improved Meteorological Systems
NOAA	National Oceanic and Atmospheric Administration
ORS	Ocean Reference Station
SBE	Sea Bird Electronics
SCS	Scientific Computer System
SHOA	Chilean Navy Hydrographic and Oceanographic Service
SST	Sea-Surface Temperature
UOP	Upper Ocean Processes Group
VMCM	Vector Measuring Current Meter
WHOI	Woods Hole Oceanographic Institution

This Page Left Intentionally Blank.

I. PROJECT BACKGROUND AND PURPOSE

The primary purposes of this cruise were to recover and then deploy a new well-instrumented surface mooring under the stratocumulus clouds found off the coast of Chile, to make shipboard meteorological and air-sea flux observations, to document and establish the accuracy of the moored meteorological observations, and to observe the oceanic and atmospheric variability in the stratus deck region.

The mooring at 20°S, 85°W was first deployed in October 2000 as a component of the Enhanced Monitoring element of the Eastern Pacific Investigation of Climate (EPIC) program and was called Stratus 1. Since then cruises (every year in October, November, or December) have recovered the old buoy and subsurface instrumentation, and deployed new moorings.

Stratus 4 (November 2003) marked the first deployment supported by NOAA's Climate Observation Program. The Stratus site has been designated an Ocean Reference Station (ORS) and a Surface Flux Reference Site. The objectives of maintaining a long term surface mooring at the Stratus site are to obtain high quality in-situ time series of surface meteorology, air-sea fluxes, upper ocean temperature, salinity, and velocity variability. This region is of critical importance to climate predictability and science and has previously been poorly sampled and not well replicated in climate models. The instrumentation deployed at the site is designed to:

- observe the air-sea exchanges of heat, freshwater, and momentum,
- observe the temporal evolution of sea surface temperature and of the vertical structure of the upper 450 m of the ocean,
- and to document and quantify the local coupling of the atmosphere and ocean in this region.

Air-sea coupling under the stratus clouds is not well understood, and numerical models show broad scale sensitivity over the Pacific to cloud and air-sea interaction parameterization in this region.

Telemetered meteorological data are not inserted on the Global Telecommunication System (GTS) for routine ingestion in numerical weather models; rather, they are made available by FTP from WHOI to provide an independent data set to evaluate operational model performance in the stratus deck region. After recovery, high sampling rate (up to 1 minute), internally recorded data are processed, and the calibrated meteorological, air-sea flux, and oceanographic data are made available for validation and improvement of models and remote sensing methods, to support development of improved air-sea flux fields, and to support various climate research activities.

The Stratus moorings carry two redundant sets of Improved Meteorological (IMET) sensors and the mooring line carries a variety of oceanographic instruments (Table 1).

Table 1: Type of measurements taken by the Stratus moorings.

Surface Measurements	Subsurface Measurements
Wind speed	Temperature
Wind direction	Conductivity
Air temperature	Current speed
Barometric pressure	Current direction
Relative humidity	
Incoming shortwave radiation	
Incoming longwave radiation	
Precipitation	

The Stratus 2005 work constituted leg 05-05 of the *R/V Ronald H. Brown* and began in Miami, USA, on September 26, 2005, and ended on October 21, 2005, in Arica, Chile. To further support surface validation of satellite data and increased understanding of the ocean in the eastern South Pacific, 16 drogue surface drifters and 8 profiling Argo floats were deployed in the South Pacific from the *Brown* along the cruise track.

Because of the importance of establishing and documenting the accuracy of the meteorological and air-sea flux records collected by the Stratus moorings, extensive shipboard meteorological and air-sea flux instrumentation was installed on the *Brown* and operated by members of the NOAA Environmental Technology Laboratory. Two full days during the cruise were dedicated to carrying out comparisons between the shipboard sensors and those on the Stratus 5 buoy, which had been at sea for 10 months. Three days were spent comparing shipboard instruments with those on the newly deployed Stratus 6 buoy. The ETL group also operated a cloud radar and launched radiosonde balloons every 4-6 hours to further document the stratus cloud region. The *Brown* also carried out routine underway oceanographic and meteorological observations. This included the logging of the ship's IMET system, thermosalinograph and C-Band radar.

This NOAA-funded cruise included participation by the NOAA Teacher-at-Sea program, with Eric Heltzel, a teacher from Evanston, Wyoming, on board. Eric was in contact with his classroom throughout the cruise, and developed educational material shared via the Teacher-at-Sea website.

All participants were invited to contribute to this cruise report, which is written to provide documentation of the work done during the cruise and to serve as the supporting documentation of the underway data that has been provided to the national observer from Chile (Alvaro Vera) who was on board the *Brown* for this cruise.

II. STRATUS 2005 CRUISE

A. Overview

Many tasks were completed during the Stratus 2005 Cruise aboard the *Brown*, including:

1. Retrieval of the Stratus 5 mooring (Section III)
2. Deployment of the Stratus 6 mooring (Section III)
3. ETL Measurements (Section IV)
4. Intercomparison of Meteorological Instruments (Section V)
5. Argos Solo Float and SVP Drifter Deployments (Section VI)
6. U. Concepcion Water Sampling (Section VI)
7. Teacher-at-Sea Program (Section VI).

The cruise (RB-05-05) began in Miami, USA, on September 26, 2005, and proceeded towards the Panama Canal. Once transiting the canal, the *Brown* proceeded towards 85°W, turned south along 85°W to the Stratus buoy, and then turned towards Arica, Chile, along 20°S. Tables 2 and 3 list the scientific participants and crewmembers aboard during the cruise. Figure 1 shows the ship track of the Stratus 2004 cruise.

Table 2: Stratus 2005 science party

Name	Affiliation
Bob Weller	WHOI
Jeff Lord	WHOI
Jason Smith	WHOI
Sean Whelan	WHOI
Paul Bouchard	WHOI
Lara Hutto	WHOI
Chris Fairall	NOAA ETL
Sergio Pezoa	NOAA ETL
Jessica Lundquist	U. Colorado CIRES
Ludovic Bariteau	U. Colorado CIRES
Virendra Ghate	U. Miami
Eric Heltzel	NOAA Teacher at Sea
Rodrigo Castro	U. Concepcion
Carolina Cisternas	U. Concepcion
Alvaro Vera	SHOA
Jorge Araya	SHOA
Edward Bradley	CSIRO

Table 3: Stratus 2005 ship's crew

Name	Title
Timothy Wright	Commanding Officer
Stacy Birk	Executive Officer
Elizabeth Jones	Field Operations Officer
Priscilla Rodriguez	Medical Officer
Silas Ayers	Ensign
Jackie Almeida	Ensign
James Brinkley	Ensign
Dave Owen	Bosun
Cornell Hill	BGL
Reggie Williams	DU
Victoria Carpenter	AB
Phil Pokorski	OS
Jonathan Shannahoff	Scientific Technician
Wayne Smith	3AE
Herbert Watson	2 nd Cook
Richard Whitehead	Chief Steward
Karen Bailey	Chief Cook
Mary O'Connell	GVA
Mike Moats	GVA
Danny Kouhestani	GVA
Danny Day	JE
James O'Claire	JE
Jesse Byrd	OS
John Gamber	W
Chris Churylo	Lead Electronics Technician
Gordon Gardipe	A2AE
Steve Layne	1AE
Frank Dunlop	CME

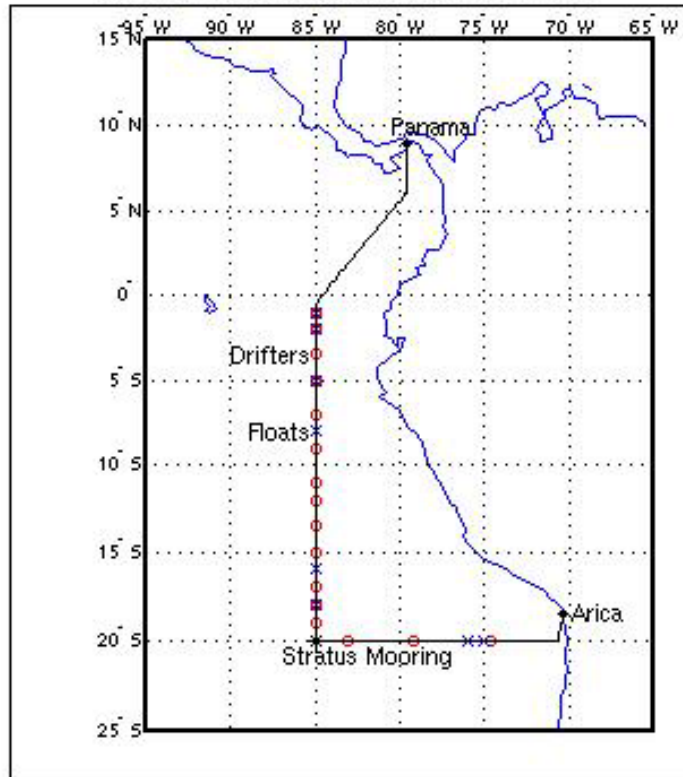

Figure 1: The Stratus 2005 cruise track, showing the Stratus mooring, and approximate locations of drifter and float deployments.

B. Pre-Cruise and Cruise Details

Preparation for the Stratus cruise began months before sailing with the initial calibration and testing of the instruments. During the summer of 2005 instruments were gathered and placed on the mooring for testing (this is referred to as the burn-in phase). Burn-in details are not presented in this cruise report, but have been documented carefully for instrument performance tracking purposes.

In September 2005, members of the UOP group met the *Brown* in Woods Hole, Massachusetts, to load equipment. Some additional equipment was hand carried and loaded in Miami, Florida, and Panama City, Panama. Loading the majority of the equipment in Massachusetts saves significant shipping costs and avoids potential international customs delays. The following is a chronology of activities conducted during the cruise.

September 25, 2005 – Members of the UOP group traveled from Boston to Miami. The Teacher at Sea met the ship in the evening.

September 26, 2005 – Loading and lashing of gear. Buoy moved more aft to allow for the container to be opened. Departed the USCG Miami Station at ~14:30 L. Went offshore for ship tests and inspection, and safety drills. Once inspectors were returned to shore by small boat, the ship began its transit at ~19:15 L.

September 27, 2005 – Underway to Panama, passing northern coast of Cuba. Alpha Omega antennas and flux package installed and started.

September 28, 2005 – Continued underway to Panama, passing between Cuba and Haiti. Began unpacking of subsurface instruments.

September 29, 2005 – Continued underway to Panama. Began setup and painting of subsurface instruments. Given access to shipboard met data.

September 30, 2005 – Began transit of Panama Canal at approximately 17:30 L and finished on October 1, 2005 at 03:30 L.

October 1, 2005 – Ship docked and began fueling at Rodman fuel pier. Remainder of science party boarded at 09:00 L.

October 2, 2005 – Ship underway at approximately 17:30 L. A demonstration of float and drifter deployment methods was given by Jeff Lord at 18:00 L.

October 3, 2005 – Course was changed during morning hours so that international waters could be entered sooner. No underway sampling as of this date. Demonstration of radiosonde deployment given at 13:30 L. Science watches began at 08:00 L, with 4 hour shifts. Watch standers responsible for float and drifter deployment, and assisting ETL group with nighttime radiosonde deployments.

October 4, 2005 – *Brown* entered international waters when passing 2°53.46N, 85°00.73W. Underway sampling was started at approximately 16:00 L.

October 5, 2005 – The first float and drifter deployments were completed.

October 6, 2006 – Continued underway along 85°W. Instrument prep, spiking, and painting continued.

October 7, 2005 – Continued underway along 85°W.

October 8, 2005 – Continued underway along 85°W.

October 9, 2005 – The bridge spotted the Stratus 5 buoy on radar at a distance of 9 nm. At 21:17 UTC, the *Brown* arrived at the buoy station, which at the time was at 19°44.0'S, 85°33.3'W. The small boat was launched, and three members of the science party were

able to give the buoy a close visual inspection. The buoy looked in good condition, and the floating SST was still moving with the surface of the water. An average water line of 60 cm below the buoy deck was seen. After the small boat was brought back onboard, the ship was moved 5 nm away from the mooring, and two deep CTD casts were completed. Also at the same time the acoustic releases for the Stratus 6 mooring were tested.

October 10, 2005 – An intercomparison of the ships instruments, and the Argos data retrieved from the Stratus 5 and 6 buoys was conducted.

October 11, 2005 – Intercomparison period continued. A meeting was held at 14:15 L for all participants in the mooring recovery operations to go over the operations plan and safety considerations.

October 12, 2005 – At 5:00 L (9:00 UTC), the ship was moved into position to communicate with the Stratus 5 acoustic release. Communications were established with the release at 10:01 UTC. The release was fired at 10:44:68 UTC at a location of 19°44.50'S, 85°31.02'W. The small boat was launched from the *Brown*, and a tag line was hooked into the cluster of glass balls that had surfaced. The first glass balls were brought onboard at 12:34 UTC using the A-frame. Recovery proceeded as planned, and the buoy itself was brought on deck at 17:44 UTC over the port side. After recovery of the mooring, all instruments were photographed and then cleaned of any bio-fouling. Due to the presence of fishing line on the Stratus 5 mooring, it was decided that a new location should be found for Stratus 6. A Sea-Beam survey began during the evening to locate a new site for the mooring.

October 13, 2005 – The Sea-Beam survey continued. The deck was rearranged and prepared for the Stratus 6 deployment.

October 14, 2005 – Deployment operations for Stratus 6 began in the morning, and the first 45 m of instruments and chain were deployed in a bottom up fashion. The buoy was lifted over the port side and placed in the water at 12:24 UTC. After the buoy was safely in the water, instrument deployment began in a top down manner. The last instrument was placed in the water at 13:43 UTC. The anchor was dropped at 17:51 UTC at a location of 20°2.747'S, 85°11.147'W. After the anchor settled, an anchor survey was conducted by ranging on the acoustic release which gave the final location of the anchor as 20°2.670'S, 85°11.305'W. The ship was moved 5 nm away from the buoy, and 2 deep CTDs were completed.

October 15, 2005 – After completion of the deep CTD casts, the ship was moved to a position 0.25 nm downwind of the buoy for an intercomparison period between the ship, ETL, and buoy sensors.

October 16, 2005 – The ship maintained its position and the intercomparison period continued.

October 17, 2005 – Intercomparison period continued until 23:00 L. At that time the ship departed the mooring station and turned towards Arica, Chile. Watches were resumed at 23:00 L as well.

October 18, 2005 – Underway east along 20°S. Watch standers resumed deployment of Argo floats and surface drifters.

October 19, 2005 – Continued underway east and float and drifter deployments.

October 20, 2005 – Continued underway east towards Arica, Chile.

October 21, 2005 – Arrived at port in Arica, Chile. The majority of the UOP group's equipment remained onboard, and was later retrieved in Charleston, SC, when the ship returned there.

III. ORS STRATUS MOORINGS

A. Overview

The buoys used in the Stratus project are equipped with meteorological instrumentation, including two Improved Meteorological (IMET) systems. The mooring line also carries vector measuring current meters, conductivity and temperature recorders, and a selection of acoustic current meters.

The WHOI mooring is an inverse catenary design utilizing wire rope, chain, nylon and polypropylene line and has a scope of 1.25 (scope is defined as slack length/water depth). The Stratus 5 surface buoy was the first deployment of a newly designed 2.7 meter diameter foam buoy with an aluminum tower and rigid bridle. The previous buoys had been similar but consisted of a single-piece aluminum hull. The design of these surface moorings took into consideration the predicted currents, winds, and sea-state conditions expected during the deployment duration.

The instrument systems recovered and deployed on the Stratus moorings are described in detail below.

B. Surface Instruments

1. Improved Meteorological (IMET) Systems

There are two independent IMET systems on the Stratus buoys. These systems measure the following parameters once per minute, and transmit hourly averages via satellite:

- relative humidity with air temperature
- barometric pressure
- precipitation
- wind speed and direction
- incoming shortwave radiation
- incoming longwave radiation
- near-surface ocean temperature and conductivity

All IMET modules for the Stratus experiment were modified for lower power consumption so that a non-rechargeable alkaline battery pack could be used. Near-surface temperature and conductivity are measured with a SeaBird MicroCat and an RS-485 interface.

A LOGR53 Main Electronics logger was used. This consists of a two-board set of CPU and interface which handles the power and communications to the individual IMET modules as well as optional PTT, internal barometer or internal A/D board. All modules are sampled at the start of each logging interval. All the "live" interval data is available via the D and E commands on the primary RS232 "console" interface used for all LOGR53 communications.

The LOGR53 CPU board is based on a Dallas Semiconductor DS87C530 microcontroller. DS87C530 internal peripherals include a real time clock and 2 universal asynchronous receiver-transmitters (uart); 2 additional uarts are included on the CPU board as well. Also present on the CPU board is a PCMCIA interface for the 20MB FLASH memory card included with the system; at a 1-minute logging interval, there is enough storage for over 400 days of data. A standard CR2032 lithium coin cell provides battery-backup for the real time clock. Operating parameters are stored in EEPROM and are *not* dependent on the backup battery. A normally unused RS485 console interface at P1 is also present on this board.

The LOGR53IF Interface board handles power and communications distribution to the IMET modules as well as interface to various options such as PTT or A/D modules. Connector P12 is the main RS232 "console" interface to the LOGR53 and can also be used to apply external power (up to about 100 MA) to the system during test. The main +12-15V battery stack (for the base logger with FLASH card) is connected to P13; the "sensor" +12-15V battery stack (which typically powers the IMET modules) is connected to P14; the "aux" battery stack (which typically powers the optional PTT) is connected to P19. Regulated +5V power for the system is produced on this board.

Parameters recorded on a FLASH card:

TIME

WND - wind east and north velocity; wind speed average, max, and min; last wind vane direction, and last compass direction

BPR - barometric pressure

HRH - relative humidity and air temperature

SWR - short wave radiation

LWR - dome temperature, body temperature, thermopile voltage, and long wave radiation

PRC - precipitation level

SST - sea surface temperature and conductivity

ADI - multiplexed optional parameter value from A/D module (only 1 of 8 in each record)

An IMET Argos PTT module is set for three IDs and transmits via satellite the most recent six hours of one-hour averages from the IMET modules. At the start of each hour, the previous hour's data are averaged and sent to the PTT, bumping the oldest hour's data out of the data buffer.

C. Subsurface Instruments

The following sections describe individual instruments on the buoy bridle and mooring line. Sections D and E will give more information specific to each mooring. Where possible, instruments were protected from being fouled by fishing lines by "trawl-guards" designed and fabricated at WHOI. These guards are meant to keep lines from hanging up on the in-line instruments.

1. Floating SST Sensor

A Sea-Bird SBE-39 was placed in a floating holder (a buoyant block of synthetic foam sliding up and down along 3 stainless steel guide rods) in order to sample the sea temperature as close as possible to the sea surface. The Sea-Bird model SBE-39 is a small, lightweight, durable and reliable temperature logger.

2. Subsurface Argos Transmitter

An NACLs, Inc. Subsurface Mooring Monitor (SMM) was mounted upside down on the bridle of the buoy. This is a backup recovery aid in the event that the mooring parted and the buoy flipped upside down.

3. SeaCat Conductivity and Temperature Recorders

The model SBE 16 SeaCat was designed to measure and record temperature and conductivity at high levels of accuracy. Powered by internal batteries, a SeaCat is capable of recording data for periods of a year or more. Data are acquired at intervals set by the user. An internal back-up battery supports memory and the real-time clock in the event of failure or exhaustion of the main battery supply. The others were mounted on in-line tension bars and deployed at various depths throughout the moorings. The conductivity cell is protected from bio-fouling by the placement of antifoulant cylinders at each end of the conductivity cell tube.

4. MicroCat Conductivity and Temperature Recorder

The MicroCat, model SBE37, is a high-accuracy conductivity and temperature recorder with internal battery and memory. It is designed for long-term mooring deployments and includes a standard serial interface to communicate with a PC. Its recorded data are stored in non-volatile FLASH memory. The temperature range is -5° to $+35^{\circ}\text{C}$, and the conductivity range is 0 to 6 Siemens/meter. The pressure housing is made of titanium and is rated for 7,000 meters. The shallowest MicroCats were mounted on the bridle of the buoy and wired to the IMET systems. These were equipped with RS-485 interfaces. The deeper instruments were mounted on in-line tension bars and deployed at various depths throughout the moorings. The conductivity cell is protected from bio-fouling by the placement of antifoulant cylinders at each end of the conductivity cell tube.

5. Brancker Temperature Recorders (TPOD)

The Brancker temperature recorders are self-recording, single-point temperature loggers. The operating temperature range for this instrument is 2° to 34°C . It has internal battery and logging, with the capability of storing 24,000 samples in one deployment. A PC is used to communicate with the Brancker via serial cable for instrument set-up and data download.

6. Brancker XR-420 Temperature and Conductivity Recorder

The Brancker XR-420 CT is a self-recording temperature and conductivity logger. The operating temperature range for this instrument is -5° to 35°C . It has internal battery and

logging, with the capability of storing 1,200,000 samples in one deployment. A PC is used to communicate with the Brancker via serial cable for instrument set-up and data download.

7. SBE-39 Temperature Recorder

The Sea-Bird model SBE-39 is a small, light weight, durable and reliable temperature logger. It is a high-accuracy temperature (pressure optional) recorder with internal battery and non-volatile memory for deployment at depths up to 10,500 meters (34,400 feet).

8. Vector Measuring Current Meters (VMCMs)

The VMCM has two orthogonal cosine response propeller sensors that measure the components of horizontal current velocity parallel to the axles of the two-propeller sensors. The orientation of the instrument relative to magnetic north is determined by a flux gate compass. East and north components of velocity are computed continuously, averaged and then stored. All the VMCMs deployed from Stratus 4 onward have been next generation models that have newer circuit boards and record on flash memory cards instead of cassette tape. Temperature was also recorded using a thermistor mounted in a fast response pod, which was mounted on the top end cap of the VMCM.

9. Aanderaa Current Meter (Stratus 5 only)

The Aanderaa Recording Current Meter, Model RCM 11, features the Mk II Doppler Current Sensor DCS 3820. The RCM comes equipped with an eight ton mooring frame and is used in-line with the mooring line.

10. RDI Acoustic Doppler Current Profiler

The RD Instruments (RDI) Workhorse Acoustic Doppler Current Profiler (ADCP, Model WHS300-1) is mounted looking upwards on the mooring line. The RDI ADCP measures a profile of current velocities.

11. SonTek Argonaut MD Current Meter

SonTek Argonaut MD current meters have been used in the upper portion of the mooring line. The three-beam 1.5Mhz single point current meter is designed for long term mooring deployments, and can store over 90,000 samples.

12. Nortek

The Nortek Aquadopp current profiler uses Doppler technology to measure currents. It has 3 beams tilted at 25 degrees and has a transmit frequency of 1 MHz. The internal tilt and compass sensors give current direction.

13. Acoustic Release

The acoustic release used on the Stratus 6 mooring is an EG&G Model 8242. This release can be triggered by an acoustic signal and will release the mooring from the anchor. Releases are tested at depth prior to deployment to ensure that they are in proper working order.

D. Stratus 5 Recovery

The Stratus 5 mooring was deployed in December 2004 and recovered in October 2005. Table 4 below gives an overview of recovery and deployment operations.

Table 4: Stratus 5 deployment and recovery overview

Deployment	Date	December 14, 2004
	Time	18:25 UTC
	Position at Anchor Drop	19° 44.728' S, 85° 31.159' W
	Deployed by	Lord, Weller
	Recorder	Colbo
	Ship	R/V <i>Ronald H. Brown</i>
	Cruise No.	RB-11-04
	Depth	4425
	Anchor Position	19° 44.741' S, 85° 31.360' W
Recovery	Date	October 12, 2005
	Time	10:44 UTC
	Position of Recovery (Release fired)	19° 44.50' S, 85° 31.02' W
	Recovered by	Lord
	Recorder	Hutto
	Ship	R/V <i>Ronald H. Brown</i>
	Cruise No.	RB-05-05

1. Mooring Description

The Stratus 5 mooring was instrumented with meteorological instrumentation on the buoy and subsurface oceanographic equipment on the mooring line, as shown in Figure 2. Tables 5 and 6, following, detail the instrumentation.

MAX. DIA. BUOY WATCH CIRCLE = 3.7 N.Miles

Position: 19°46'S, 85°30'W

2.7 m Surlyn Foam MOBS Buoy with:
 (2) IMET/ARGOS Telemetry,
 (1) Floating Sea Surface Temperature Sensor

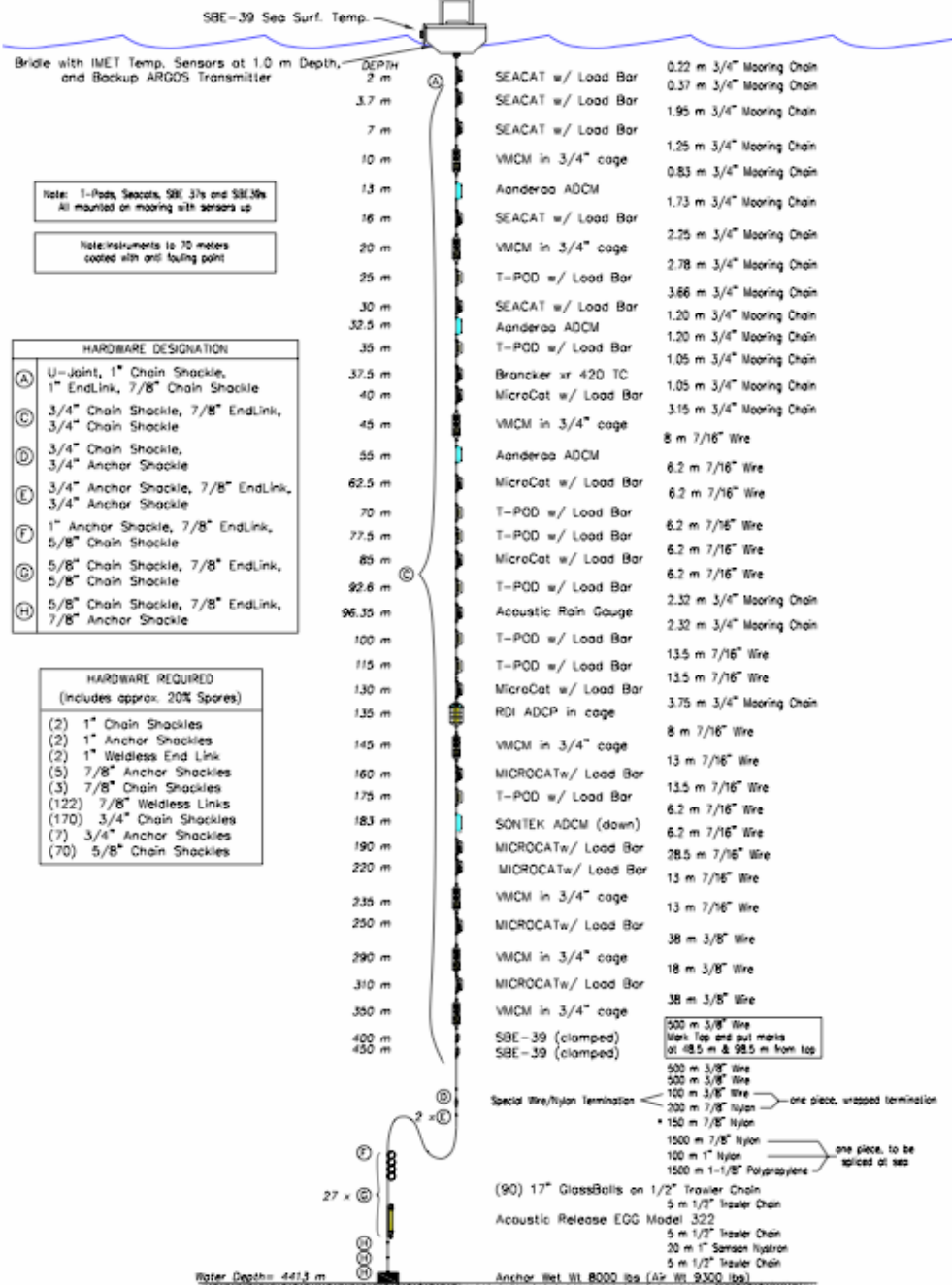

STRATUS-5 MOORING
 Version 2 - 08/20/04

Figure 2. Stratus 5 mooring diagram.

Table 5: Stratus 5 surface instrumentation

Instrument	ID Number	Height⁶ (cm)	Version
System #1			
Data Logger	L-04		LOGR53 v2.70
Relative Humidity	HRH 216	244	v3.2
Wind Module	WND 221	270.5	v3.5/v1.5
Precipitation	PRC 206	239	v3.4/v1.7
Longwave Radiation	LWR 218	282.5	v3.5/v1.6
Shortwave Radiation	SWR 219	282.5	v3.3/v1.6
Barometric Pressure	BPR 216	247	v3.3 (Heise)
Argos Transmitter (Wildcat PTT #12789)	ID 27916 ID 27917 ID 27918		
System #2			
Data Logger	L-05		LOGR53 v2.70
Relative Humidity	HRH 232	246	V3.2
Wind Module	WND 225	271	V3.5/v1.5
Precipitation	PRC 205	239	V3.4/v1.7
Longwave Radiation	LWR 502	283	V3.5/v1.6
Shortwave Radiation	SWR 209	282.5	V3.3/v1.6
Barometric Pressure	BPR 217	247	V3.3 (Heise)
Argos Transmitter (Wildcat PTT #18171)	ID 27919 ID 27920 ID 27921		
Argos SIS (SN #104)	24576		

⁶ Heights given are measured from the buoy deck, which was estimated to be 0.6 m above the mean water line. The Stratus 5 mooring consisted of a new synthetic foam buoy which rides higher in the water than the previous aluminum 3 m discus buoys.

Table 6: Stratus 5 subsurface instrumentation

Depth (m)	Instrument	Serial Number	Measurement	Sampling Rate (s)
Floater	SBE39	0718	Temp	300
0.81 ⁷	SBE37	1305	Temp and Salinity	300
0.81 ³	SBE37	1841	Temp, Salinity, and Pressure	300
2	SBE16	1873	Temp and Salinity	300
3.7	SBE16	1875	Temp and Salinity	300
7	SBE16	1880	Temp and Salinity	300
10	VMCM	037	Velocity and Temp	60
13	Aanderaa	013	Velocity and Temp	30 min interval, 600 pings per interval
16	SBE16	1881	Temp and Salinity	300
20	VMCM	032	Velocity and Temp	60
25	TPOD	3258	Temp	1800
30	SBE16	2323	Temp and Salinity	300
32.5	Aanderaa	078	Velocity and Temp	30 min interval, 600 pings per interval
35	TPOD	3283	Temp	1800
37.5	XR-420	10514	Temp and Salinity	300
40	SBE37	1325	Temp and Salinity	300
45	VMCM	038	Velocity and Temp	60
55	Aanderaa	079	Velocity and Temp	30 min interval, 600 pings per interval
62.5	SBE37	1326	Temp and Salinity	300
70	TPOD	3704	Temp	1800
77.5	TPOD	3762	Temp	1800
85	SBE37	1328	Temp and Salinity	300
92.6	TPOD	3830	Temp	1800
96.3	SBE37	1909	Temp, Salinity, and Pressure	300
100	TPOD	3831	Temp	1800
115	TPOD	3836	Temp	1800
130	SBE37	1329	Temp and Salinity	300
135	RDI	1218	Velocity and Temp	60 pings per hour, 1 hour average, 12 cells, 10 m in size
145	VMCM	042	Velocity and Temp	60
160	SBE37	1330	Temp and Salinity	300
175	TPOD	3837	Temp	1800
183	SonTek	D208	Velocity and Temp	Averaging rate 110 sec, Sampling rate 900 sec
190	SBE37	1906	Temp and Salinity	300
220	SBE37	1908	Temp and Salinity	300
235	VMCM	058	Velocity and Temp	60
250	SBE37	2012	Temp	300
290	VMCM	0075	Velocity and Temp	60
310	SBE37	2015	Temp and Salinity	300
350	VMCM	010	Velocity and Temp	60
400	SBE39	0048	Temp	300
450	SBE39	0049	Temp	300
~4400	Acoustic Release	339	N/A	N/A

⁷ Assumes buoy deck is 0.60m above mean waterline

2. Recovery Process

The Stratus 5 mooring was recovered on October 12, 2005. To prepare for recovery the *Brown* was positioned roughly 1/2 mile upwind from the anchor position. About 40 minutes after the release was fired, the glass balls surfaced. Once the glass balls were on the surface, the ship approached the cluster of balls along the starboard side. The ship's small boat was used to tow the glass balls aft where they could be secured to the trawl winch via a lifting pendant.

The winch leader was reeved through the trawl block in the A-frame. A messenger line was thrown to the small boat, where the pendant was attached and pulled back to the stern. The pendant was shackled into the winch leader. The *Brown* went ahead slowly to bring the glass balls astern. The winch hauled up to bring the cluster of glass balls over the stern. The TSE mooring winch and two air tuggers were used to control the glass balls as they were pulled forward and lowered to the deck. Two stopper lines were snapped into a sling link and then made fast to the deck cleats. The winch leader was payed out and disconnected.

Once the glass balls were on board, stopper lines were hooked into the 1-1/8" polypropylene and made fast. The winch was then shackled into the sling link above the release. The winch hauled the release on board. Glass balls were disconnected and hauled to the port side near the rag top container to be loaded by the crane.

As the glass balls were being cleared, the 1-1/8" polypropylene was wound onto the ship's capstan. The 1500m of 1-1/8" polypropylene, 100m of 1" nylon and 1500m of 7/8" nylon were hauled in and placed in 3 wire baskets.

Hauling stopped at the end of the 1500-meter shot of nylon. The mooring winch leader was hooked into the sling link between the 1500 and 150-meter shot of nylon. Load was transferred to the winch, and the termination was broken at the 1500 meter nylon shot.

The recovery continued using the TSE mooring winch. The 150m shot of nylon, the 200/100m nylon and 3/8" wire rope special termination, and the three shots of 500 meters of 3/8" wire rope were hauled in. The two SBE-39s clamped on the 3/8" wire rope were recovered.

The procedure for recovering the instruments went as follows: with A-frame boomed out over the stern, the winch hauled in the wire. The first instrument was stopped about 2 feet above the deck and the A-frame was boomed in. Two stopper lines were hooked into the sling link and made fast to the deck cleats. The winch payed out slowly to lower the instrument to the deck. The instrument was disconnected from the hardware and moved to a staging area for pictures. The wire rope from the winch was then shackled to the load.

The winch took up the slack and the stopper lines were eased off and then cleared. The A-frame was boomed out and hauling continued until the next instrument.

The above procedure was continued throughout the recovery operation until the Aanderaa current meter at 55 meters was recovered. Once the Aanderaa was recovered, a shackle and 5/8" pear link was attached to a link on the 3/4" chain. A slip line was used to set the buoy and remaining 45 meters of instruments adrift.

The rescue boat was deployed. It approached the buoy and hooked into the lifting bail with a pendant and lift sling. A tag line was tied into the lifting pendant. The small boat towed the buoy to the port quarter of the *Brown*. A heaving line was thrown to the small boat and was tied to the tag line. The line was hauled back to the ship with the port side crane standing by. The pendant was hooked into the block of the crane. The crane lifted the buoy from the water and swung inboard so the buoy would rest on the side of the ship. The tugger lines were attached to bails on the buoy. The buoy was hoisted up and then swung inboard while the tuggers kept tension on the buoy to keep from swinging.

Once the buoy was on deck aircraft straps were used to secure the buoy. A stopper line was used to stop off on the 0.37 m shot of 3/4" chain between the first and second instruments. The forward tugger with a chain hook shackled to the thimble was also used to stop off on the chain. The shackle was disconnected from the universal plate on the bottom of the buoy.

A sling was placed through the link at the top of the first instrument and hooked in the crane's block. The crane took the load, and the stopper line was eased off and cleared. The crane hoisted the first two instruments and stopper line was hooked into a bite of chain. Once the stopper line had the load, the crane lowered the instruments to the deck. The instruments were disconnected and the crane was repositioned over the load. The sling was placed through the sling link and hooked into the crane. The crane took the load and the stopper line was eased off and cleared. The crane lifted the next section of instruments and the above procedure was repeated to recover the remaining instruments.

3. Time Spikes

Timing spikes were applied to some of the instruments recovered from Stratus 5. These spikes were performed so that responses in the data file could be checked against a known time. Water was added to the precipitation modules. Black bags were placed on the long and shortwave radiation sensors to block as much light as possible. Wind vanes and rotors were removed. Instruments measuring temperature were placed in ice baths or in a large refrigerator. The VMCM rotors were spun and then blocked. Tables 7, 8, and 9 give the details for pre-deployment and post-recovery timing spikes. Additional information on clock checks is given in Appendix D.

Table 7: Stratus 5 pre-deployment timing spikes

Instrument	Serial #	Time 1		Time 2	
Precipitation	205, 206	5 Dec 04	10:33:30		
LWR	218, 502	4 Dec 04	12:13:30	4 Dec 04	13:08:00
SWR	209, 219	4 Dec 04	12:13:30	4 Dec 04	13:08:00
WND	221, 225	4 Dec 04	12:14:00	4 Dec 04	13:08:00
SST	1841, 1305	3 Dec 04	10:27:00	3 Dec 04	17:30:00
SBE39	0718, 0048, 0049	4 Dec 04	11:42:00	4 Dec 04	12:42:00
SBE37	1325, 1326, 1328, 1329, 1330, 1906, 1908, 2012, 2015	4 Dec 04	12:43:00	4 Dec 04	14:02:00
SBE37	1909	5 Dec 04	10:28:00	5 Dec 04	14:02:00
SBE16	1873, 1875, 1880, 1881, 2323	5 Dec 04	12:47:00	5 Dec 04	13:47:00
Brancker	3258, 3282, 3704, 3762, 3830, 3831, 3836, 3837	5 Dec 04	10:25:00	5 Dec 04	12:42:00
Aanderaa	013, 078, 079	4 Dec 04	14:03:00	4 Dec 04	15:48:00
RDI	1218	7 Dec 04	11:02:00	7 Dec 04	14:10:00
XR 420	10514	7 Dec 04	11:03:30	7 Dec 04	13:53:00
VMCM	042	9 Dec 04	15:08:30	9 Dec 04	19:26:30
	032	9 Dec 04	15:09:30	9 Dec 04	19:27:30
	038	9 Dec 04	15:10:30	9 Dec 04	19:29:30
	075	9 Dec 04	15:11:30	9 Dec 04	19:28:30
	058	9 Dec 04	15:13:30 15:14:30	9 Dec 04	19:30:30
	010	9 Dec 04	15:16:30	9 Dec 04	19:32:30
	037	9 Dec 04	15:17:30	9 Dec 04	19:31:30

Table 8: Stratus 5 Post-Recovery Spikes

Instrument	Serial #	Time 1 (UTC)		Time 2 (UTC)	
PRC	206	13 Oct 05	17:21:00		
PRC	205	13 Oct 05	17:22:00		
LWR	218, 502	13 Oct 05	12:15:00	13 Oct 05	17:24:00
SWR	219, 209	13 Oct 05	12:15:00	13 Oct 05	17:24:00
SST	1841, 1305	12 Oct 05	19:12:00	12 Oct 05	20:04:00
WND	221, 225	13 Oct 05	11:44:00		
SBE37	1325, 1326, 1328, 1329, 1330, 1906, 1908, 2012, 2015, 1909	13 Oct 05	20:17:30	13 Oct 05	21:33:00
SBE39	0718, 0048, 0049	13 Oct 05	07:54:30	13 Oct 05	09:06:00
SBE16	1873, 1875, 1880, 1881, 2323	13 Oct 05	18:58:00	13 Oct 05	20:08:00
Brancker TPODs	3258, 3282, 3704, 3762, 3830, 3831, 3836, 3837	13 Oct 05	11:39:00	13 Oct 05	14:32:00
Aanderaa	13, 78, 79	13 Oct 05	07:50:00	13 Oct 05	10:04:00
RDI	1218	13 Oct 05	07:48:00	13 Oct 05	11:04:00
Brancker XR420	10514	13 Oct 05	07:56:00	13 Oct 05	09:07:30
Sontek	D208	13 Oct 05	07:52:00	13 Oct 05	11:05:30

Table 9. NGVM Post-recovery rotor spins

Serial Number	Time Blocked (UTC)	Spin 1 Time (UTC)	Spin 2 Time (UTC)
010	15:45:00, 12 OCT 05	15:03:30, 15 OCT 05	17:47:30, 15 OCT 05
032	19:32:00, 12 OCT 05	15:02:30, 15 OCT 05	17:45:30, 15 OCT 05
075	15:44:00, 12 OCT 05	15:04:30, 15 OCT 05	17:48:30, 15 OCT 05
058	15:46:00, 12 OCT 05	14:59:30, 15 OCT 05	17:44:30, 15 OCT 05
042	16:07:00, 12 OCT 05	14:58:30, 15 OCT 05	17:43:30, 15 OCT 05
038	19:51:00, 12 OCT 05	14:54:30, 15 OCT 05	17:42:30, 15 OCT 05
037	17:59:00, 12 OCT 05	14:52:30, 15 OCT 05	17:41:30, 15 OCT 05

4. Stratus 5 Instrument Performance

There were seven NGVMs deployed on the Stratus 5 mooring. Of the seven, six recorded for the entire period. NGVM-042 did not record for the entire period and was found to have a battery voltage of 1.1v. The FLASH card had approximately 310,000 records, where the others had approximately 450,000 records. NGVM-010 deployed at 350 meters was found to have a broken blade on the top propeller. Fishing line was found on NGVM-038 at 45 meters and on NGVM-032 at 20 meters. Both NGVMs had the fishing line wrapped into the propellers and stopped them from spinning.

There were three SBE-39's deployed. The two that were deployed deep on the mooring had full records. The floating SBE39, 0718, did not have communication upon recovery. The battery voltage was found to be 7.7v. This instrument will be sent back to Sea-Bird for evaluation.

There were three Aanderaa current meters deployed on the mooring. None of the three lasted the whole length of the deployment. The #13 instrument performed for approximately eight months, the #78 instrument performed for approximately six months, and the #79 performed for approximately one month. All three units will be sent to the manufacturer for evaluation.

The remainder of the subsurface instruments appeared to have functioned without problem.

One IMET module, HRH 232, failed on Dec. 14, 2005. A reason for the failure has not been determined as of the time of this report.

5. Antifoulant performance

Previous moorings have been used as test beds for a number of different antifouling coatings. The desire has been to move from organotin-based antifouling paints to a product that is less toxic to the user, and more environmentally friendly. These tests have previously led the Upper Ocean Process group to rely on E Paint Company's, SUNWAVE, as the antifouling coating used on the buoy hull, and EPaint ZO for most of the instruments at 70 meters depth or above. A proprietary formula, called Bio-Grease, was developed for use on the ADCP/ADCM transducers.

Instead of the age-old method of leaching toxic heavy metals, the patented E Paint approach takes visible light and oxygen in water to create peroxides that inhibit the settling larvae of fouling organisms. Photo generation of peroxides and the addition of an organic co-biocide, which rapidly degrades in water to benign byproducts, make E Paint an effective alternative to organotin antifouling paints. These paints have been repetitively tested in the field, and show good bonding and anti-fouling characteristics.

SUNWAVE is a two-part, water-based, antifouling coating that offers a truly eco-friendly approach to controlling biofouling. The product claims superior adhesion and durability. Results from this study will validate SUNWAVE as a viable alternative to organotin, copper, and other more toxic coatings.

Below are observations of the recovered buoy and instruments.

- Almost all traces of SUNWAVE paint had eroded from the foam section of the buoy hull. Gooseneck barnacles were attached to the foam from the waterline to the base of the buoy. The density of barnacles was heavier than on the Stratus 4 discus buoy. However, surface fouling in the Stratus 4 mooring was remarkably light for this area. There were a few mature barnacles, but most appeared to be young. The application of a tie coat, plus additional coats of SUNWAVE should reduce barnacles in the future. Stratus 5 did not use a tie coat.
- Overall fouling on instrumentation was typical for the Stratus moorings. Instruments in the first 15 meters were heavily fouled.
- Gooseneck barnacles were found on instruments as deep as 183 meters.
- Heavy fouling was seen on instruments down to 10 meters. However, the 10-meter VMCM stings and props were relatively free of goosenecks. The clamps on the 10 meter VMCM pressure case were heavily fouled.
- Moderate fouling ended at 45 meters, and fouling below 70 meters was negligible.
- Most of the ZO used on instruments had ablated almost completely. On some instruments below 10 meters it appears to have been effective at reducing fouling near the instrument sensors.
- There is no significant fouling on Ti trawl guards or stainless steel cage parts. It doesn't appear worthwhile to paint these parts.
- Load bars get some fouling whether coated or not.
- Barnacle density is heaviest near neoprene strips, and at crevices such as where Delrin clamps wrap around an instrument, or where T/C shields mount to pressure cases.
- Fouling on VMCM propellers was very light. There was no evidence of the algae that coated the mooring segments down to 20 meters on the Stratus 4 mooring.

Continued testing of products will help us determine the most effective ones to use. Instruments recovered on the Stratus 3 mooring showed that a coating of Trilux was more effective than e-paint SN-1. An E-paint product, ZO, has similar properties to the Trilux coating. The ZO formula was used extensively on subsurface instruments for Stratus 5. Table 10 details anti-foulant applications on Stratus 5.

Table 10. Stratus 5 antifoulant applications

Description	Coating	Color	Coats	Method
Buoy Hull	SUNWAVE	White	3	Roller
Floating SST	ZO	White	2	Brush
SST Frame	Trilux w/biolux	Red	2	Brush
SBE 37s on hull bottom	Sunwave	White	1	Brush
Load Bars and Trawl Guards	ZO	WHITE	Brushed in area of sensors. Some bars had residual coatings	
**All instruments to 70 Meters	ZO	White	1	Brush – applied only in area of sensors
Seacat/Microcat shields	SN-1	White	1	Spray
RDI ADCP heads (135 M) RDI Frame Aanderaa heads	Trilux w/biolux	Red	1	Brush
VMCM #037 10 m				
Props	Epaint “p” -TBT	White/Clr	2/2	Spray/Spray
Sting	ZO – TBT	White/Clr	2/2	Brush/Spray
Cage	Trilux - TBT	Red/Clr	2/2	Brush/Spray
VMCM #032 20 m				
Props	Epaint “p” -TBT	White/Clr	2/2	Spray/Spray
Sting	ZO – TBT	White/Clr	2/2	Brush/Spray
Cage	Trilux	Red/Clr	2/2	Brush/Spray
VMCM #038 45 m				
Props	Clean Seas -TBT	Red/Clr	2/2	Spray/Spray
Sting	ZO – TBT	White/Clr	2/2	Brush/Spray
Cage	Trilux	Red/Clr	2/2	Brush/Spray
VMCM #042 145 m				
Props	Clean Seas -TBT	Red/Clr	2/2	Spray/Spray
Sting	ZO – TBT	White/Clr	2/2	Brush/Spray
Cage	Trilux	Red/Clr	2/2	Brush/Spray
VMCM case	Mylar	Clear	1	Wrapped
VMCM clamps	ZO	White	1	Brush
ADCM/ADCP transducers	Epaint – Bio Grease		1	Grease applied with gloves

** Brancker T-pod coated at end cap near thermistor and down case 3”.

Seacats and microcats – shields removed and coated, tubes coated, ½ of pressure case coated.

Aanderaas are coated with ZO around heads (not transducers), down stem to case.

VMCMs below 145 meters had some coatings on props and cages by coincidence. These instruments will show no fouling whether treated or not.

E. Stratus 6 Deployment

The Stratus 6 mooring was deployed on October 14, 2005, and is scheduled to be recovered approximately one year later. Table 11 gives an overview of deployment operations.

Table 11: Stratus 6 deployment details

Deployment	Date	October 14, 2005
	Time	17:51 UTC
	Position at Anchor Drop	20° 02.747' S, 85° 11.147' W
	Deployed by	Lord
	Recorder	Hutto
	Ship	R/V <i>Ronald H. Brown</i>
	Cruise No.	RB-05-05
	Depth	4481 m
	Anchor Position	20° 2.6703' S, 85° 11.3054' W

1. Mooring Description

The Stratus 6 mooring was equipped with meteorological instrumentation on the buoy, and subsurface oceanographic equipment on the mooring line. Tables 12 and 13 detail the instrumentation, and Figure 3 is a schematic representation of the mooring.

Table 12: Stratus 6 surface buoy instrumentation

Instrument	ID Number	Height from buoy deck (cm)	Firmware Version
Data Logger	L-01		LGR53 v2.70
Relative Humidity ⁸	221	218	VOSHRH53 v3.2
Wind Module ⁹	212	260	VOSWND53 v3.5
Precipitation ¹⁰	207	249	VOSPRC53 v3.4
Longwave Radiation ¹¹	221	279	VOSLWR53 v3.5
Shortwave Radiation	505	279	VOSSWR53 v3.3
Barometric Pressure ¹²	504	247	VOSBPR53 v3.3 (Heise)
Argos Transmitter (Wildcat PTT #12789)	ID 9805 ID 9807 ID 9811		
Data Logger	L-02		LGR53 v2.70
Relative Humidity	208	216	VOSHRH53 v3.2
Wind Module	348	262	VOSWND53 v3.5
Precipitation	505	249	VOSPRC53 v3.4
Longwave Radiation	204	279	VOSLWR53 v3.5
Shortwave Radiation	207	279	VOSSWR53 v3.3
Barometric Pressure	221	247	VOSBPR53 v3.3 (Heise)
Argos Transmitter (Wildcat PTT #18171)	ID 24337 ID 27970 ID 27971		
HRH (stand alone)	503	222	VOSHRH53 v3.2
LWR (stand alone)	506	279	VOSLWR53 v3.5
SIS Beacon #22	ID 11427		

⁸ Height measured to top of shield.

⁹ Height measured to rotor axis.

¹⁰ Height measured to top of funnel.

¹¹ Radiometer heights measured to base of dome.

¹² Height measured to center of port.

Table 13: Stratus 6 subsurface instrumentation

Depth (m)	Instrument	Serial Number	Measurement	Sampling Rate
Floater	SBE39	0716	Temp	5 minutes
1.5 ¹³	SBE37	1837	Temp and Salinity	5 minutes
1.5 ¹¹	SBE37	1834	Temp and Salinity	5 minutes
2	SBE37	1899	Temp and Salinity	5 minutes
3.7	XR420	10515	Temp and Salinity	5 minutes
7	SBE37	2011	Temp and Salinity	5 minutes
10	VMCM	057	Velocity and Temp	1 minute
15	Nortek	333	Velocity and Temp	1 min average, once per hour 13 cells, 1 m each
16	SBE37	1901	Temp and Salinity	5 minutes
20	VMCM	030	Velocity and Temp	1 minute
25	TPOD	2764	Temp	30 minutes
30	SBE37	1905	Temp and Salinity	5 minutes
32.5	Sontek	D197	Velocity and Temp	60 sec average, once per 15 min
35	TPOD	3839	Temp	30 minutes
40	SBE37	1912	Temp and Salinity	5 minutes
45	VMCM	029	Velocity and Temp	1 minute
62.5	SBE37	1902	Temp and Salinity	5 minutes
70	TPOD	4481	Temp	30 minutes
77.5	TPOD	4488	Temp	30 minutes
85	SBE37	1910	Temp and Salinity	5 minutes
92.5	TPOD	4489	Temp	30 minutes
100	VMCM	053	Velocity and Temp	1 minute
115	TPOD	4494	Temp	30 minutes
130	SBE37	1903	Temp and Salinity	5 minutes
135	RDI	1220	Velocity and Temp	12 cells, 1 meter each 60 pings, 1 per sec, for a period of one min, once per hour
145	VMCM	076	Velocity and Temp	1 minute
160	SBE16	0927	Temp and Salinity	5 minutes
175	TPOD	4495	Temp	30 minutes
183	Sontek	D193	Velocity and Temp	60 sec average, once per 15 min
190	SBE16	1877	Temp and Salinity	5 minutes
220	SBE16	0928	Temp and Salinity	5 minutes
235	VMCM	008	Velocity and Temp	1 minute
250	SBE16	0994	Temp and Salinity	5 minutes
290	VMCM	034	Velocity and Temp	1 minute
310	SBE16	0993	Temp and Salinity	5 minutes
350	VMCM	040	Velocity and Temp	1 minute
400	SBE39	0282	Temp	5 minutes
450	SBE39	0203	Temp	5 minutes
~4400	Acoustic Releases	30845, 30848	N/A	N/A

¹³ Depth from buoy deck.

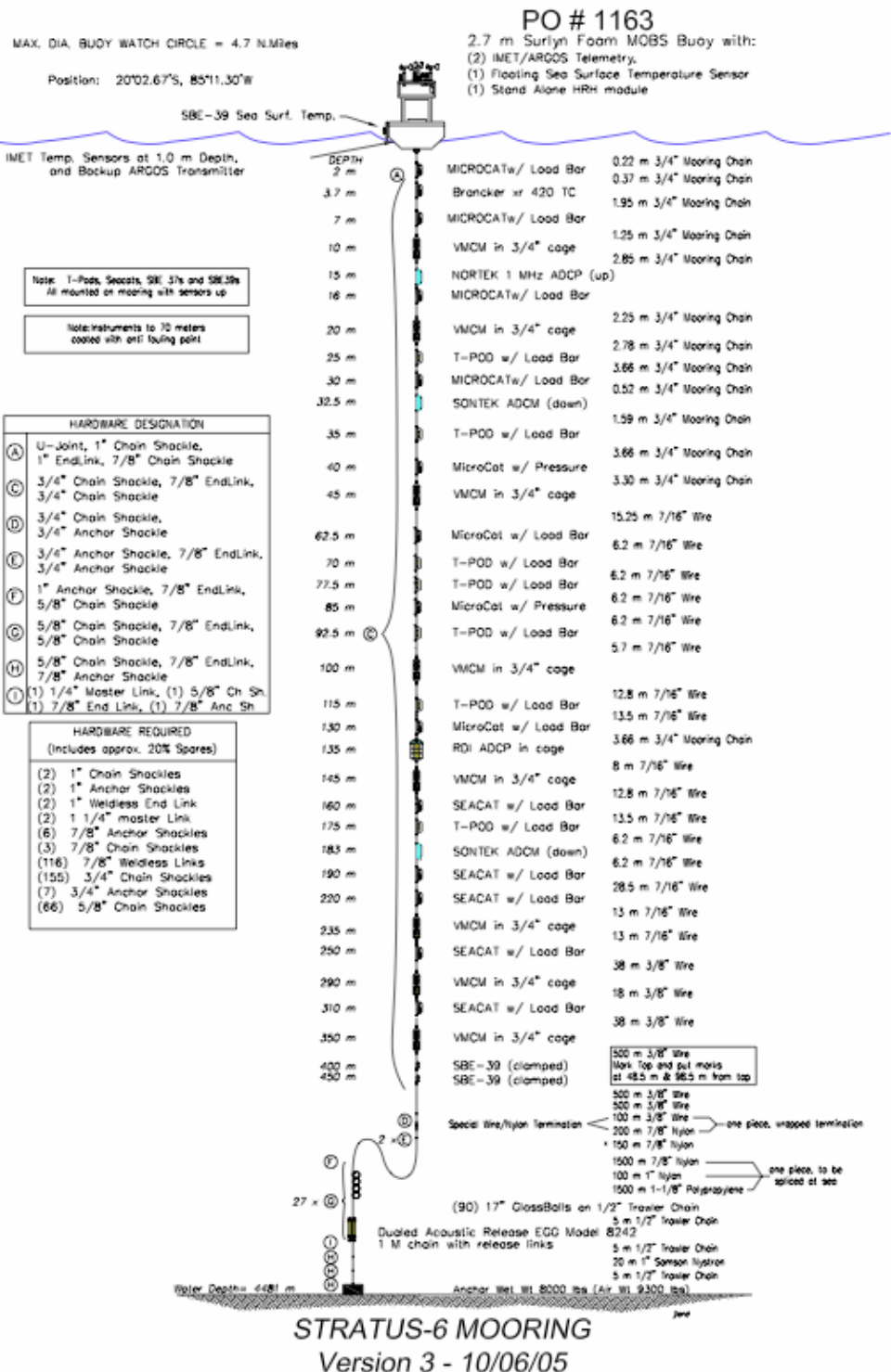

Figure 3: The Stratus 6 mooring diagram

2. Time Spikes

Timing spikes were applied to some of the Stratus 6 mooring instrumentation prior to deployment. These spikes will help with data processing by allowing timing to be checked on the instruments. Table 14 details the timing spike information, and NGVM information follows.

Table 14. Stratus 6 pre-deployment timing spikes.

Instrument	Serial Number	Time 1		Time 2	
		Date	Time	Date	Time
SBE37 (salinity spike)	1834, 1837	4 Oct 05	14:05:00	4 Oct 05	19:25:00
SBE37 (ice added)	1834, 1837	4 Oct 05	17:36:00	4 Oct 05	19:25:00
SWR	505, 207	4 Oct 05	17:46:00	4 Oct 05	21:06:00
LWR	221, 204, 506	4 Oct 05	17:46:00	4 Oct 05	21:06:00
PRC (flushed and drained)	207, 505	4 Oct 05	14:25:00		
PRC (add water)	207, 505	4 Oct 05	17:25:00		
PRC (add water)	207, 505	6 Oct 05	13:20:00		
PRC (flushed and drained)	207, 505	6 Oct 05	16:12:00		
SBE16	0146, 0927, 0928, 0993, 0994, 1877	30 Sep 05	15:12:00	30 Sep 05	16:08:00
SBE37	1899, 1901, 1902, 1903, 1905, 1910, 1912, 2011	30 Sep 05	13:21:00	30 Sep 05	14:40:00
SBE39	0203, 0282, 0716, 0717	30 Sep 05	13:21:00	30 Sep 05	14:40:00
Brancker TPODs	3764, 3859, 4481, 4488, 4489, 4494, 4495	4 Oct 05	10:33:00	4 Oct 05	12:51:00
Nortek	333	5 Oct 05	09:31:00	5 Oct 05	13:04:00
RDI	1220	5 Oct 05	13:07:00	5 Oct 05	17:47:00
Brancker XR420	10515	4 Oct 05	10:33:00	4 Oct 05	11:33:00
Sontek	D193, D197	5 Oct 05	09:31:00	5 Oct 05	09:31:00

NGVM Spins:

NGVM-008 Firmware: VMCM2 v3.10

TPOD Firmware: VMTPOD53 v3.00

Start sampling @ 17:44:00, 6 OCT 05

1st sample @ 17:45:00, 6 OCT 05

1st spin: 13:37:30, 8 OCT 05

2nd spin: 16:21:30, 10 OCT 05

Bands off: 13:26:00, 14 OCT 05

Depth: 235 m

NGVM-029 Firmware: VMCM2 v3.10
TPOD Firmware: VMTPOD53 v3.00
Start sampling @ 15:44:00, 7 OCT 05
1st sample @ 15:45:00, 7 OCT 05
1st spin: 13:36:30, 8 OCT 05
2nd spin: 16:20:30, 10 OCT 05
Bands off: 11:45:00, 14 OCT 05
Depth: 45 m

NGVM-030 Firmware: VMCM2 v3.10
TPOD Firmware: VMTPOD53 v3.00
Start sampling @ 14:14:00, 7 OCT 05
1st sample @ 14:15:00, 7 OCT 05
1st spin: 13:33:30, 8 OCT 05
2nd spin: 16:18:30, 10 OCT 05
Bands off: 12:02:00, 14 OCT 05
Depth: 20 m

NGVM-034 Firmware: VMCM2 v3.10
TPOD Firmware: VMTPOD53 v3.00
Start sampling @ 15:59:00, 6 OCT 05
1st sample @ 16:00:00, 6 OCT 05
1st spin: 13:35:30, 8 OCT 05
2nd spin: 16:19:30, 10 OCT 05
Bands off: 13:31:00, 14 OCT 05
Depth: 290 m

NGVM-040 Firmware: VMCM2 v3.10
TPOD Firmware: VMTPOD53 v3.00
Start sampling @ 14:59:00, 6 OCT 05
1st sample @ 15:00:00, 6 OCT 05
1st spin: 13:34:30, 8 OCT 05
2nd spin: 16:17:30, 10 OCT 05
Bands off: 13:37:00, 14 OCT 05
Depth: 350 m

NGVM-053 Firmware: VMCM2 v3.10
TPOD Firmware: VMTPOD53 v3.00
Start sampling @ 13:29:00, 6 OCT 05
1st sample @ 13:30:00, 6 OCT 05
1st spin: 13:38:30, 8 OCT 05
2nd spin: 16:22:30, 10 OCT 05
Bands off: 12:56:00, 14 OCT 05
Depth: 100 m

NGVM-057 Firmware: VMCM2 v3.10
TPOD Firmware: VMTPOD53 v3.00
Start sampling @ 13:14:00, 7 OCT 05
1st sample @ 13:15:00, 7 OCT 05
1st spin: 13:31:30, 8 OCT 05
2nd spin: 16:16:30, 10 OCT 05
Bands off: 12:08:00, 14 OCT 05
Depth: 10 m

NGVM-076 Firmware: VMCM2 v3.10
TPOD Firmware: VMTPOD53 v3.00
Start sampling @ 18:44:00, 6 OCT 05
1st sample @ 18:45:00, 6 OCT 05
1st spin: 13:39:30, 8 OCT 05
2nd spin: 16:23:30, 10 OCT 05
Bands off: 13:09:00, 14 OCT 05
Depth: 145 m

3. Antifoulant Application

The Stratus 6 mooring was used for continued testing of E-paint products. Table 15 shows methods used for coating the buoy hull and instrumentation for the Stratus 6 deployment.

Table 15: Stratus 6 antifoulant application details

Description	Coating	Color	Coats	Method
Buoy Hull	Bar Rust Primer SUNWAVE	Gray White	1 4	Roller Roller
Floating SST	ZO	White	2	Brush
SST Frame	ZO	White	2	Spray
SBE 37s on hull bottom	ZO	White	1	Brush
Load Bars Trawl guards not treated	ZO	WHITE	Brushed in area of sensors. Some bars had residual coatings	
**All instruments to 70 Meters	ZO	White	1	Brush – applied only in area of sensors
Seacat/Microcat shields	ZO	White	1	Brush
RDI ADCP heads (135 M)	BIO-GREASE	Clr	1	Grease applied with gloves
RDI Frame –top section Residual trilux on heads	ZO(residual trilux)	White	1	
VMCM #57 10 m	Epaint “p” - ZO ZO	Gray	2	Spray
Props		White	2	Brush/Spray
Sting		White	1	Brush
VMCM # 030 10 m	Epaint “p” - ZO ZO	Gray	2	Spray
Props		White	2	Brush/Spray
Sting		White	1	Brush
ADCM/ADCP transducers	Epaint – Bio Grease		1	Grease applied with gloves

** Brancker T-pod coated at end cap near thermistor and down case 3”

SeaCat and MicroCat – shields removed and coated, tubes coated, ½ of pressure case coated

Sontek (32.5 M), Nortek (15M), Brancker XR420 painted all over case and load bar with ZO

4. Deployment Process

The Stratus 6 surface mooring was set using the UOP two-phase mooring technique. Phase 1 involves the lowering of approximately 50 meters of instrumentation followed by the buoy, over the port side of the ship. Phase 2 is the deployment of the remaining mooring components through the A-frame on the stern.

The TSE winch was pre-wound with these components listed from deep to shallow:

- 150 m 7/8” nylon
- 200 m 7/8” nylon – nylon to wire shot
- 100 m 3/8” wire – nylon to wire shot
- 500 m 3/8” wire
- 500 m 3/8” wire
- 500 m 3/8” wire
- 38 m 7/16” wire
- 18 m 7/16” wire
- 38 m 7/16” wire
- 50 m 7/16” wire

A tension cart was used to pretension the nylon and wire during the winding process.

The ship was positioned 7.5 nautical miles downwind and down current from the desired anchor site (see Figure 4). An earlier bottom survey indicated this track would take the ship over an area with consistent ocean depth.

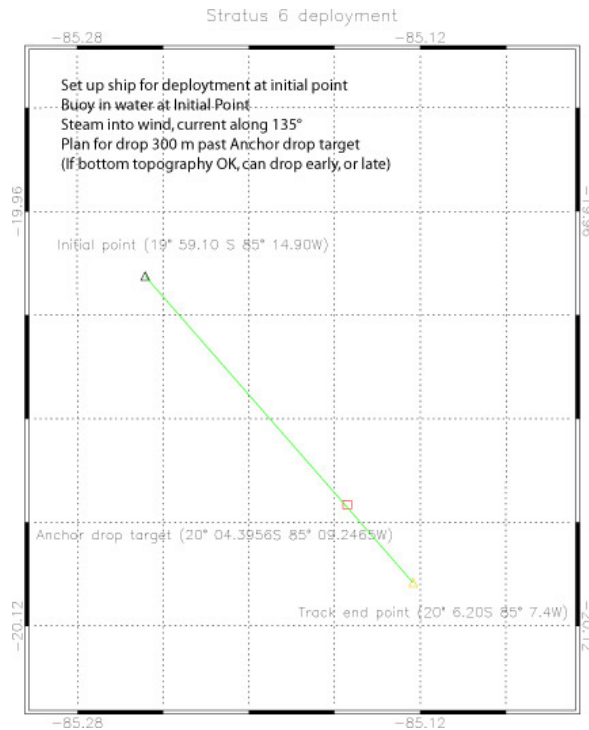

Figure 4. Map showing track plan for Stratus 6 deployment

Prior to the deployment of the mooring, approximately 80 meters of 3/8" diameter wire rope was payed out to allow the end to be passed out through the center of the A-frame and around the aft port quarter and forward along the port rail to the instrument lowering area.

Four wire handlers were stationed around the aft port rail. The wire handlers' job was to keep the hauling wire from fouling in the ship's propellers and to pass the wire around the stern to the line handlers on the port rail.

To begin the mooring deployment, the ship hove to with the bow positioned with the wind slightly on the port bow. The crane was extended out so there was a minimum of 10 meters of free whip hanging over the instrument lowering area. All subsurface instruments for this phase had been staged in order of deployment on the port side main deck. All instrumentation had their chain or wire shot pre-rigged to the top of the instrument. A shackle and ring was attached to the bottom of each shot of chain or wire.

The first instrument segment to be lowered was the VMCM at 45m. The instrument lowering began by shackling the end of the hauling wire to the 15-meter shot of wire attached to the bottom end of the VMCM. The crane hook suspended over the instrument lowering area was lowered to approximately 1 meter off the deck. A sling was hooked onto the crane and passed through a ring to the top of the 5.7 meter shot of chain shackled to the top of the VMCM cage.

The crane was raised up so that the chain and instrument were lifted off the deck. The crane slowly lowered the wire and attached mooring components into the water. The wire handlers positioned around the stern eased wire over the port side, paying out enough wire to keep the mooring segment vertical in the water. The stopper line was hauled in enough to take the load from the crane and made fast to the deck. A stopper was attached to the top link of the instrument array as a backup. The hook on the crane was removed. Lowering continued with 10 more instruments and chain segments being picked up and placed over the side.

The operation of lowering the upper mooring components was repeated up to the 7 meter MicroCat T/C. The load from this instrument array was stopped off using a slip line passed through a link shackled into the chain approximately 0.5 meters from the top of the chain. This allowed enough slack to the bottom of the 2 instruments and chain that had been previously shackled to the 1" end link attached to the buoy universal joint.

The second phase of the operation was launching the buoy. Three slip lines were rigged on the buoy to maintain control during the lift. Lines were rigged on the bridle, tower bail and a buoy deck bail. The 30 ft slip line was used to stabilize the bottom of the buoy and allow the hull to pivot on the apex at the start of the lift. The 50 ft tower slip line was rigged to check the tower as the hull swung outboard. A 75 ft buoy deck bail slip line was rigged to prevent the buoy from spinning as the buoy settled in the water. This is used so the quick release hook, hanging from the crane's whip, could be released without fouling against the tower. The buoy deck bail slip line was removed just following the release of the buoy. An additional line was tied to the crane hook to help pull the crane block away from the tower's meteorological sensors once the quick release hook had been triggered and the buoy cast adrift.

With three slip lines in place, the crane swung over the buoy. The quick release hook, with a 1" sling link, was attached to the crane block. Slight tension was taken up on the whip to hold the buoy. The ratchet straps securing the buoy to the deck were removed. The stopper line holding the suspended 45 meters instrumentation was eased off to allow the buoy to take the hanging load. The buoy was raised up and swung outboard as the slip lines kept the hull in check. The lower slip line was removed first, followed by the tower slip line. Once the discus had settled into the water (approximately 20 ft from the side of the ship), and the release hook had gone slack, the quick release was tripped. The crane swung forward to keep the block away from the buoy. The slip line to the buoy deck bail was

cleared at about the same time. The ship then maneuvered slowly ahead to allow the buoy to come around to the stern.

The winch operator slowly hauled in the slack wire once the buoy had drifted behind the ship. The ship's speed was increased to 1/2 knot through the water to maintain a safe distance between the buoy and the ship. The bottom end of the shot of wire shackled to the hauling wire was pulled in and stopped off at the transom.

A traveling block was suspended from the A-frame using the heavy-duty air tugger to adjust the height of the block. The next instrument, 62.5 meter depth MicroCat and pre attached wire shot was shackled to the end of the stopped off mooring. The free end of wire was passed through the block and shackled to the free end of the hauling wire. The hauling wire was pulled onto the TSE winch to take up the slack. The winch slowly took the mooring tension from the stopper lines.

The block was hauled up to about 8 feet off the deck, lifting the MicroCat off the deck as it was raised. By controlling the A-frame, block height, and winch speed, the instrument was lifted clear of the deck and over the transom. The winch payed out to the next termination. The termination was stopped off using lines on cleats, and the hauling wire removed while the next instrument was attached to the mooring.

The next several instruments were deployed in a similar manner. When pulling the slack on the longer shots of wire, the terminations were covered with a canvas wrap before being wound onto the winch drum. The canvas covered the shackles and wire rope termination to prevent damage from point loading the lower layers of wire rope and nylon on the drum. This process of instrument insertion was repeated for the remaining instruments down to 350 meters.

While the wire and nylon line was being payed out, the crane was used to lift the 92 glass balls out of the rag top container. These balls were staged fore and aft, in four ball segments, just aft of the container. When all the wire and nylon on the winch drum was payed out, the end of the nylon was stopped off to a deck cleat.

An H-bit cleat was positioned in front of the TSE winch and secured to the deck. The free end of the 3000 meter shot of nylon/polypropylene line, stowed in three cardboard "D containers" was dressed onto the H-bit and passed to the stopped off mooring line. The shackle connection between the two nylon shots was made. The line handler at the H-bit pulled in all the residual slack and held the line tight against the H-bit. The stopper lines were then eased off and removed.

The person handling the line on the H-Bit kept the mooring line parallel to the H-bit with moderate back tension. The H-bit line handler and one assistant eased the mooring line out of the wire basket and around the H-bit at the appropriate payout speed relative to the ships speed.

When the end of the polypropylene line was reached, pay out was stopped and a Yale grip was used to take tension off the polypropylene line. The winch tag line was shackled to a 5-meter shot of 1/2" chain. The other end of the chain was shackled to the end of the polypropylene line. The polypropylene line was removed from the H-Bit. The winch line and mooring line were wound up taking the mooring tension away from the stopper line on the Yale grip. The stopper line was removed. The TSE winch payed out the mooring line until half of the 5 meter shot of chain was over the ship's transom.

The 92 glass balls were bolted on 1/2" trawler chain in 4 ball (4 meter) increments. The first two sets of glass balls were dragged into position and shackled together. One end was attached to the mooring at the transom. The other end was shackled to the winch leader. The winch pulled the mooring line tight, stopper lines were removed, and the winch payed out until 7 of the eight balls were off the stern. Stopper lines were attached, the winch leader was removed, and the process repeated until all 92 balls were deployed.

A 5-meter shot of chain was shackled to the last glass ball segment. The acoustic releases were shackled to the chain. Another 5-meter chain section was shackled to the releases. A 20 meter Nystron anchor pendant was shackled to that chain, and another 5 meter section of 1/2" chain was shackled to the anchor pendant. The mooring winch wound up these components until it had the tension of the mooring. The acoustic releases were laying flat on the deck.

The air tugger hauling line was passed through a block hung in the A-frame. A 1/2" chain hook was shackled to the end of the tugger line. The chain hook was attached to the mooring about two meters below the acoustic releases. The A-frame was positioned all the way in. The tugger line was pulled in and the releases were raised from the deck. As the winch payed out, the A-frame moved out and eased the release over the transom without touching the deck. The tugger payed out and the chain hook was removed.

The winch continued to pay out until the final 5-meter shot of chain was just going over the transom. A shackle and link was attached about three meters up this segment of chain. A heavy-duty slip line was passed through the link and secured to two cleats on the deck. The winch payed out until tension was transferred to the slip line. The end of the chain was removed from the winch and shackled to the anchor on the tip plate.

Deck bolts were removed from the anchor tip plate. The starboard crane was shifted so the crane whip would hang over, and slightly aft of the anchor. The whip was lowered and the whip hook secured to the tip plate bridle. A slight strain was applied to the bridle. The chain lashings were removed from the anchor. The slip line was removed, transferring the mooring tension to the 1/2" chain and anchor. The line was pulled clear and the crane whip raised 0.5 meters lifting the forward side of the tip plate causing the anchor to slide overboard.

5. Site of the Stratus 6 Surface Mooring

When Stratus 5 was recovered, long-line fishing gear was found in two VMCMs and other instruments. Also, at the time of the recovery operations, a long-line fishing vessel was seen, first on radar and then visually, steaming toward the site of the Stratus 5 buoy. Because of this, the decision was made to moor the Stratus 6 buoy roughly 40 nm to the east-southeast. On the night of October 12 and into the morning of October 13, a SeaBeam survey was done to locate a region of suitable depth that would offer a target for mooring deployment.

With the prevailing wind from the SE, with the current typically toward the NW, and with ridges in the bottom topography in the region running NW-SE, the survey was set up with a deployment track along 135° in mind. Figure 5 shows the survey on the night of October 12 and early on October 13.

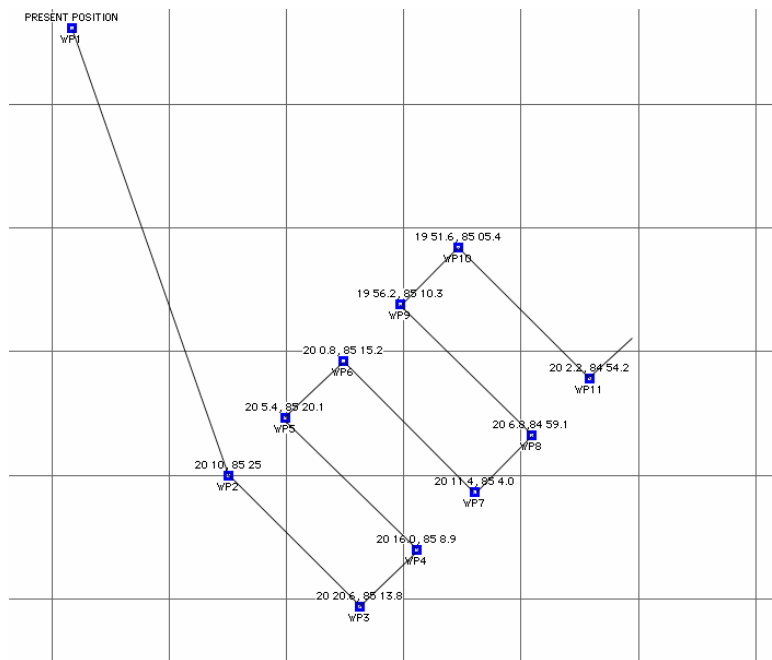

Figure 5. Track line for the SeaBeam survey to locate the site for deployment of Stratus 6.

A bottom contour map was available on a monitor in the computer lab after the survey was completed. Based on this map an anchor target site of the $20^\circ04.3956'S$, $85^\circ09.2465'W$ was identified, with approximately 4480 m of water depth and a broad surrounding region providing the ability to either deploy earlier or later along the deployment track line.

A deployment track line was set up to steam along 135° . An initial position of $19^\circ59.1'S$, $85^\circ14.9'W$, a target position for the anchor drop of $20^\circ04.3965'S$, $85^\circ09.2465'W$ (2.5 nm along the line) and an end point to steer toward of $20^\circ6.20'S$, $85^\circ7.4'W$ (2.5 nm further

along 135°) defined the track line. The ship took up a position to the north of the initial point, anticipating being set to the south while the buoy was deployed.

The mooring line was on the winch and passed out the A-frame and around to the port rail aft of the containers. Line tenders kept this line on board. Working on the port rail by where the buoy is secured, the chain and instrumentation in the upper 50 m of the mooring was attached to the mooring line and lowered into the water. Line tenders minded the line around stern. The buoy was deployed on a quick release hook off port side with the ship moving its stern away from buoy and go ahead to bring the buoy astern. With the buoy astern the ship began to make progress back toward the planned track line. The mooring was stopped off and instruments attached in line. Ship speeds were kept low to keep tension down.

Once all instruments were attached, the ship proceeded along the track line. Ship speed and line payout rate were monitored to make sure line was not payed out faster than the progress through water and that line tensions were not too high. The glass balls were attached; the acoustic release was attached and connected to the anchor. At this time, the bottom depth and topography was checked. The depth was acceptable and the deployment of the anchor went forward.

The anchor drop position was 20°02.747'S, 85°11.147'W, and the water depth (corrected using Matthews Tables) was 4481 m. Following the anchor deployment, the anchor was allowed to settle and a three-point acoustic survey was conducted. Figure 6 shows the deployment track line with the track of the ship during deployment and the anchor survey. Table 16 gives the three positions that were occupied and the acoustic range obtained at each.

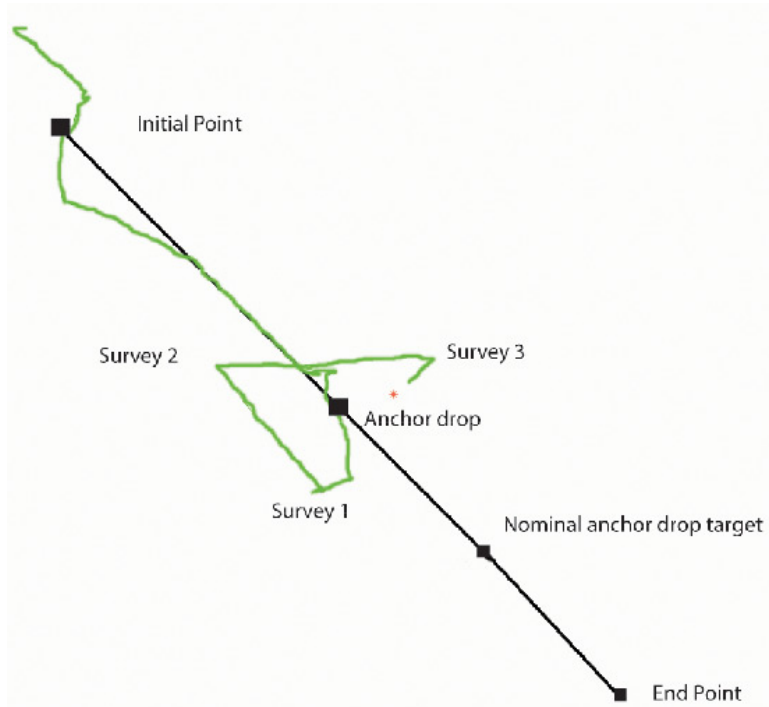

Figure 6. Planned deployment track in black, with ships actual track in green.

Table 16. Anchor position survey details

Ship position			
Latitude	Longitude	Slant Range (msec)	Horizontal Range (m)
20° 03.6564 S	85° 11.3912 W	3199	1816.3
20° 02.0742 S	85° 12.7912 W	3497	2801.6
20° 02.0100 S	85° 09.9166 W	3461	2697.7

A Matlab program written by Art Newhall, called Survey, was used to generate three slant range arcs and identify the intersection. The three range arcs are shown in Figure 7 and the resulting identification of an anchor position by survey in Figure 8.

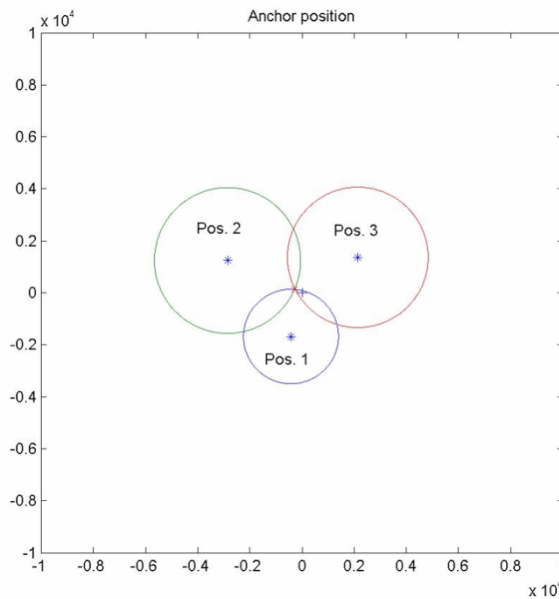

Figure 7. The three survey positions with slant range arcs generated by Survey.

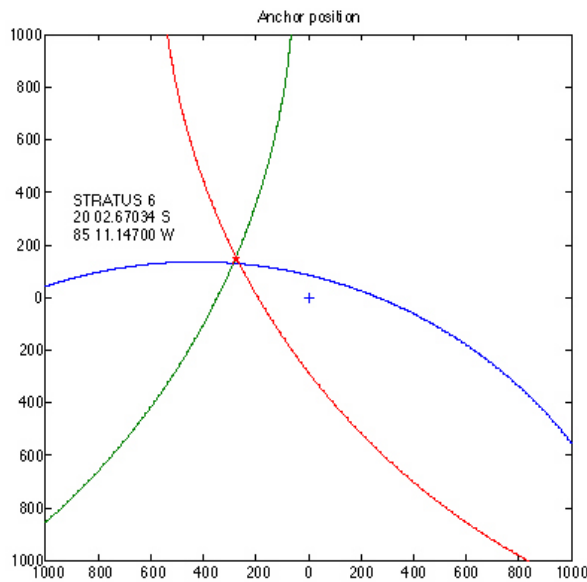

Figure 8. The anchor position determined by Survey, 20°02.67034'S, 85°11.30540'W.

A second MATLAB program, called Ccours was also run and generated the intersection of horizontal range arcs and anchor position shown in Figure 9. The fallback based on the Survey anchor position was 310.6 m (6.9%); the fallback based on the Ccours anchor position was 296.2m (6.6%).

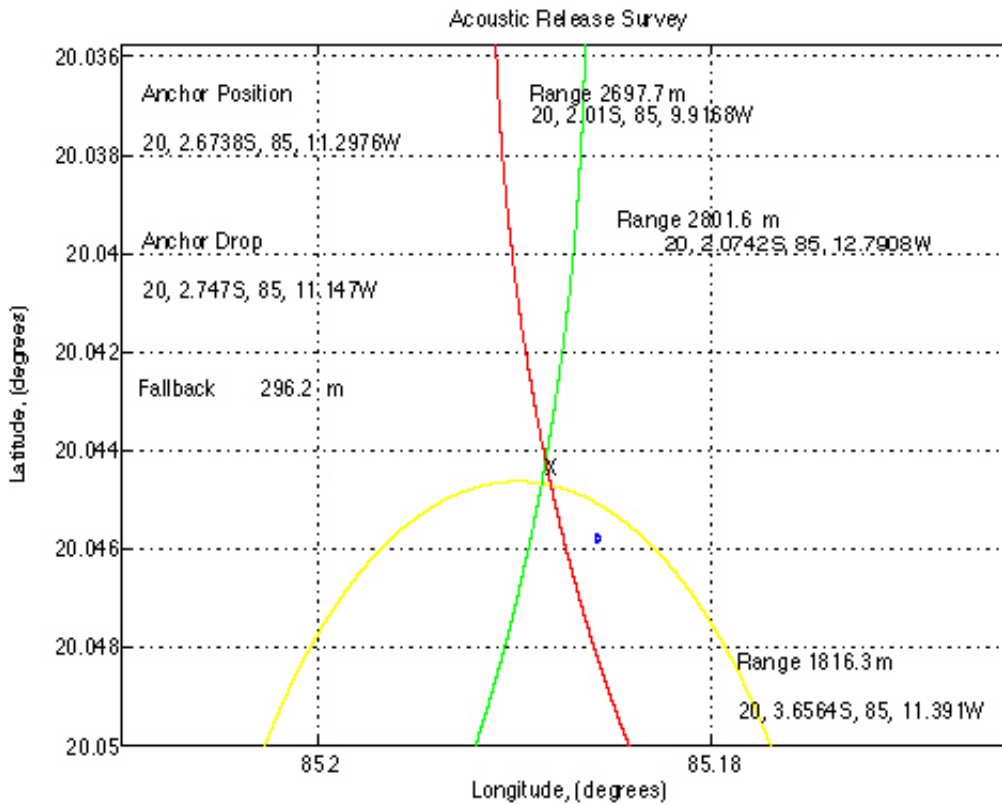

Figure 9. The horizontal range arcs and anchor position (20° 2.6738'S, 85° 11.2975'W) determined using Ccours.

While Ccours has been used to generate anchor positions in the past, it has more subjectivity in the choice of the best location based on the range arcs; and the Survey-based position, 20°02.67034'S, 85°11.30540'W, is chosen as the anchor position for Stratus 6.

IV. ETL MEASUREMENTS

A. Background on Measurement Systems

The ETL air-sea flux and cloud group conducted measurements of fluxes and near-surface bulk meteorology during the fall field program to recover the WHOI Ocean Reference Station buoy at 20°S, 85°W. The ETL flux system was installed initially on the *Brown* at Woods Hole, MA, in September 2005, shaken down on a three-day test cruise from WHOI to Charleston, and brought back into full operation in Panama in late September 2005.

The air-sea flux system consists of six components: (1) A fast turbulence system with ship motion corrections mounted on the jackstaff. The jackstaff sensors are: INUSA Sonic anemometer, OPHIR IR-2000 IR-hygrometer, LiCor LI-7500 fast CO₂/hygrometer, and a Systron-Donner motion-pak. (2) A mean T/RH sensor in an aspirator on the jackstaff. (3) Solar and IR radiometers (Eppley pyranometers and pyrgeometer) mounted on top of a seatainer on the 02 deck. (4) A near surface sea surface temperature sensor consisting of a floating thermistor deployed off port side with outrigger. (5) A Riegl laser rangefinder wave gauge mounted on the bow tower. (6) An optical rain gauge mounted on the bow tower. Slow mean data (T/RH, PIR/PSP, etc) are digitized on a Campbell 23x datalogger and transmitted via RS-232 as 1-minute averages. A central data acquisition computer logs all sources of data via RS-232 digital transmission:

1. Sonic Anemometer
2. Licor CO₂/H₂O
3. Slow means (Campbell 21x)
4. Laser wave sensor
5. OPHIR hygrometer
6. Systron-Donner Motion-Pak
7. Ship's SCS
8. ETL GPS

The 8 data sources are archived at full time resolution. At sea we run a set of programs each day for preliminary data analysis and quality control. As part of this process, we produce a quick-look ascii file that is a summary of fluxes and means. The data in this file come from three sources: The ETL sonic anemometer (acquired at 21.3 Hz), the ship's SCS system (acquired at 2 sec intervals), and the ETL mean measurement systems (sampled at 10 sec and averaged to 1 min). The sonic is 5 channels of data; the SCS file is 15 channels, and the ETL mean system is 42 channels. A series of programs are run that read these data files, decode them, and write daily text files at 1 min time resolution. A second set of programs reads the daily 1-min text files, time matches the three data sources, averages them to 5 or 30 minutes, computes fluxes, and writes new daily flux files. The 5-min daily flux files have been combined and rewritten as a single file to form the file *flux_5hf_stratus_05.txt*. The 1-min daily ascii files are stored as *proc_nam_dayDDD.txt* (nam='pc', 'scs', or 'son'; DDD=yearday where 000 GMT January 1, 2005 =1.00). File structure is described in the original matlab files that write the data, *prt_nam_05.m*.

Atmospheric aerosols were measured with a Particle Measurement Systems (PMS) Lasair-II aerosol spectrometer. The Lasair-II draws air through an intake and uses scatter of laser light from individual particles to determine the size. Particles are counted in six size bins: 0.1-0.2, 0.2-0.3, 0.3-0.5, 0.5-1, 1-5, and greater than 5.0 μm diameter. The ETL system was mounted in the seatainer on the 02 deck with the intake on the upwind side of the container. The system ran at 1.0 cfm (0.028 m^3/min) sample volume flow rate with a count deconcentrator that reduces the counts a factor of 10 (to prevent coincidence errors).

ETL/Flux and UM also operated six remote systems: a Vaisala CT-25K cloud base ceilometer, a 9.4 GHz vertically pointed Doppler cloud radar, a 915 MHz Doppler wind profiler, and three microwave radiometer systems. The RHB's scanning Doppler C-band radar was not operated because of a transmitter failure. The ceilometer is a vertically pointing lidar that determines the height of cloud bottoms from time-of-flight of the backscatter return from the cloud. The time resolution is 30 seconds and the vertical resolution is 15 m. The raw backscatter profile and cloud base height information deduced from the instrument's internal algorithm are stored in daily files with the naming convention *CRVYYDDD.raw* where YY=04 and DDD=julian day. File structure is described in *ceilo_readme_stratus04.txt*.

ETL/Flux and UM used an integrated system in a seatainer that includes the 3-channel microwave radiometer (20.6-31.65-90.0 GHz Mark II unit). The UM 9.4-GHz radar antenna was mounted on the roof of the seatainer. The cloud radar systems can be used to deduce profiles of cloud droplet size, number concentration, liquid water concentration, etc. in stratus clouds. If drizzle (i.e., droplets of radius greater than about 50 μm) is present in significant amounts, then the microphysical properties of the drizzle can be obtained from the first three moments of the Doppler spectrum. Two Radiometrics Inc. 'Mailbox' microwave radiometers were also deployed. The old unit is the same one that has been deployed on numerous TAO/PACS cruises and on EPIC2001. For the first time, we brought a new Mailbox unit just acquired in September. This unit is destined for an Arctic project but the schedule allowed it to be used on this cruise. The new unit does continuous tip curves and produces profiles of water vapor distribution.

For the record, five or six times a day photographs have been taken of the sky in four directions relative to the ship (over starboard, astern, port, and bow), especially at times of rapid cloud development. The timing of each set of four photographs has been carefully noted so that the directions can be converted to earth coordinates, knowing the ship's heading at that time.

B. Selected Samples

1. Flux Data

Preliminary flux data is shown for yearday=286 (October 13, 2005) as the RHB remains on station at the buoy site at 20°S, 85°W (Figure 10.). The time series of ocean and air temperature is given in Figure 11. The water temperature is about 18.5 C and the air

temperature is about 17.0 C. The apparent increase in air temperature near the end of the day is caused by the ship turning downwind. The true wind direction (Figure 12) and true wind speed (Figure 13) show modulation by boundary-layer scale organization. The effect of clouds on the downward solar flux is shown in Figure 14 and on the IR flux in Figure 15. For the solar flux, broken clouds are apparent in the jagged form of the curve during the morning. For IR flux, clear skies have values of about 320 Wm^{-2} and cloudy skies values around 390 Wm^{-2} . The IR flux and solar flux show a large break in the clouds in the afternoon. Figure 16 shows the time series of four of the five primary components of the surface heat balance of the ocean (solar flux is left out). The largest term is the latent heat (evaporation) flux, followed by the net IR flux (downward minus upward); the sensible heat flux and the flux carried by precipitation are very small. We are using the meteorological sign convention for the turbulent fluxes so all three fluxes actually cool the interface in this case. The time series of net heat flux to the ocean is shown in Figure 17. The sum of the components in Figure 16 is about -130 Wm^{-2} , which can be seen in the night time trace; the large positive peak during the day is due to the solar flux. The integral over the entire day gives an average flux of 61 Wm^{-2} , indicating strong warming of the ocean mixed layer even on an overcast day.

2. Remote Sensing Data

A sample ceilometer 24-hr time series for cloud base height for October 14 is shown in Figure 18. This day had 83% cloud cover and two sets of cloud base heights: the dominant stratocumulus layer with cloud bases 1000 to 1300 m and occasional lower level ‘scud’ clouds with bases about 500 m. Small amounts of drizzle can be seen as the few low-altitude dots early in the day. A sample time-height cross section (Figure 19) from the UM cloud radar is shown for a 24-hr period on October 14. The panels indicated the intensity of the return (upper), the mean fall velocity of the scattering droplets (middle panel), and the Doppler width of the return. This happens to be a day with low cloud cover; clouds are fairly thin with tops at 1.0–1.5 km. Light drizzle events are apparent as the light blue colors (2 m/s fall speed) in the mean Doppler panel; the radar is much more sensitive to drizzle than the ceilometer.

Time series from two of the microwave radiometers for day 285 (October 12) are shown in Figure 20. The upper panel shows column integrated water vapor; the lower panel shows the integrated liquid water path (LWP) of the stratus clouds. The data are from the two Radiometrics mailbox radiometers (referred to as *new* and *old* units). The new unit was obtained for use in the Arctic and is presently using Arctic coefficients to retrieve vapor and liquid quantities. The two are highly correlated, but differ by a factor of 10 in liquid water. This will be sorted out when retrievals with the new system are done with appropriate coefficients.

A sample time series from the laser wave gauge is shown in Figure 21. This device measures the range from a point on the mast to a point on the ocean. The distance includes the motions of the sea surface (waves) plus motion of the ship up and down relative to

mean sea level. The ship motion component will be removed using motion correction data from the flux system.

The wind profiler operates at 33 cm wavelength where it is sensitive enough to detect returns from turbulent variations in radar refractive index, principally associated with gradients in atmospheric moisture; it also sensitive to precipitation. Sensitivity to moisture gradients causes the marine inversion to show up clearly as a band of increased backscatter intensity. Both of these factors cause improved height performance in stormy conditions. During Stratus 2005 the profiler gave continuous retrievals of the boundary-layer wind profile through the inversion. Sea clutter tends to invalidate the winds at heights below 500 m, although the minimum usable height depends on the amount of whitecapping, sea state, the dryness of the atmosphere, and ship operational factors (underway versus stopped, etc). A sample profiler wind is shown in Figure 22 in comparison with the balloon sondes and the near-surface observations from the ship. Winds in the boundary layer are predominately from the SE.

C. Cruise Summary Results

1. Basic Time Series

The ship track for the entire cruise is shown in Figure 23. The 5-min time resolution time series for sea/air temperature are shown in Figure 24 and for wind speed and N/E components in Figure 25. The change in conditions for the first five days of the record is associated with the run south along 85°W from Panama. Then on day 291 we departed the WHOI location and moved toward the DART buoy at 20°S, 74.8°W. The near-surface sea-air temperature difference is about 1 C in the vicinity of the WHOI buoy. It increases to more than 2 C on days 284–285 during the drizzly and broken cloud phase. The mean diurnal cycle for the wind components (Figure 26) shows a weak diurnal variation with a minimum at 1600 local time. Primarily because of the healthy wind speeds (about 9 m/s), there is only a small diurnal signal (0.10 C) in the sea surface temperature. Time series for flux quantities are shown as daily averages. Figure 27 gives the flux components and Figure 28 the cloud forcing for net surface radiative fluxes. Cloud forcing is the difference in the measured radiative flux from that which would be expected if there were no clouds. It is essentially a measure of the effect of clouds on the energy budget of the ocean. A negative cloud forcing implies the cloud cools the ocean (e.g., by reflecting solar flux).

The diurnal cycle of cloudiness (i.e., thinning or clearing after local noon) at 20°S leads to fairly large values of net heat flux and solar flux; afternoon clearing leads to much greater 24-hr average solar flux. Just for amusement, bulk meteorological variables and turbulent heat fluxes are shown for the transect from 0°S to 20°S along 85°W is shown in Figure 29. This shows the winds peaking at 15°S with a maximum in latent heat flux at 125 Wm⁻². The Eastern return transect (Figure 30) looks similar to transects along 20°S in previous years.

Data from the PMS Lasair-II aerosol spectrometer is shown in Figure 31. This instrument counts particles in size ranges from 0.1 to 5 μm diameter based on scattering of light from

a laser beam. This size range includes most of the so-called accumulation-mode aerosols that represent most of the particles activated to form droplets in clouds. Thus, the total number of aerosols counted by this device is expected to correlate with cloud condensation nuclei and the number of cloud drops. The distribution is normally strongly bimodal as a result of cloud processing in the marine boundary layer. The Lasair-II only observes the large particle size mode. The concentration varies with a time scale of several days. This is the result of the complex interaction between entrainment, advection, production and scavenging of aerosols. The most interesting feature this year is the dramatic decrease that occurred on day 285. In 2004 the average total number concentration from December 8th to the 18th was 180 (cm⁻³). In 2005, the median in the vicinity of the buoy was 85 (cm⁻³).

2. Boundary Layer and Cloud Properties

Beginning at 0000 UTC on October 5 and ending at 2300 UTC on October 18 we completed 72 successful rawinsonde launches. While at the WHOI buoy sondes were launched 6 times daily; otherwise, they were launched 4 times daily. A time-height color contour plot of temperature is shown in the upper panel of Figure 32; the lower panel shows the relative humidity. A pronounced temperature inversion is evident at approximately 1.2-1.6 km. The time series of wind speed and direction are shown in Figure 33. The winds are consistent with climatology, with southeasterlies prevailing within the boundary layer and westerlies aloft. The nominal height for the transition from westerlies to easterlies descended steadily during the experiment in coincidence with the moisture transition described above. The boundary-layer inversion is more clearly seen in potential temperature (Figure 34). Here the BL depth was initially about 1.0 km on the equator but was fairly constant at 1.4 km in the region of the buoy except for a clear diurnal cycle with a maximum about 1000 UTC.

The time series of cloud base height from the ceilometer is shown in Figure 35. Three different microwave radiometer systems were used on the cruise. The microwave radiometers are calibrated using a tipcal process that requires clear skies. With the Mark II system, this is done manually. The 32 GHz channel of the Mark II misbehaved on the cruise. At this writing we don't know if it is a hardware problem or a gain drift (a gain drift would be cured by frequent tipcals). Several tipcals were done in port in Woods Hole, but during the cruise sky conditions did not permit new tipcals with the lone exception of day 284. The Radiometrics systems perform tipcals automatically: the old unit hourly and the new unit continuously. The time series of data from the two mailbox systems is shown in Figure 36. Both systems agreed fairly well with sonde column water vapor values in the stratus region. The new system showed much higher correlation with the sondes than the old system, but the slope was not as close to 1.0 and it was biased high. This suggests that the scanning strategy of the new system gives much better sampling but there are still retrieval issues to solve.

D. Intercomparisons

Intercomparisons are a key strategy in data quality assurance for the climate reference buoys and the use of research vessel measurements for climate-quality data archives. The

ETL flux system is intended to produce measurements of turbulent flux bulk variables and radiative fluxes that have the required accuracy for climate research. For this cruise, a set of intercomparisons were done for bulk meteorology and radiative fluxes.

*The ETL flux system acquired all relevant ship IMET-based measurements.

*ETL and ship radiative fluxes were compared with the WHOI buoy (sitting on the deck) and an array of IMET radiative sensors (mounted in an array on the 03 deck).

*A carefully executed set of psychrometer measurements were taken regularly during the cruise as a reference for air temperature and humidity.

1. ETL-Ship Comparisons

We compared ETL and ship measurements for wind speed and direction, water and air temperature, relative humidity, and solar and IR downward radiative flux. All measurements agreed within the accuracy required for flux evaluations. The ship wind system does experience flow blockage by the jackstaff for relative winds from the starboard side. A detailed analysis will be done later.

2. Psychrometer Comparisons

As in some previous cruises, the accuracy of our Vaisala temperature and humidity measurements was checked against a hand-held Assman psychrometer. About 5 times throughout the day, when the wind was within $\pm 90^\circ$ of dead ahead, the Assman wet and dry bulb temperatures were sampled through either port or starboard chocks on the foredeck. These locations were adopted on earlier cruises, rather than over the bow itself, because they offer shading of the thermometers from the sun. The chocks are at a height of approximately 7.5 meters above the sea surface, compared with 15m for the Vaisala. A sample calculation based on the z/L value indicated that the temperature correction with height would be around 0.03°C . This is less than the resolution with which the thermometers can be read (0.1°C). These are spot values to be compared with our standard 5-minute averages, so some scatter is expected, but averaged over the cruise the comparison should be valid.

ETL, ship, and psychrometer values were compared for air temperature and specific humidity. The 7.5-meter psychrometer values were corrected to 15 m using similarity theory (based on the measured fluxes). The average correction was -0.02°C for temperature and -0.12 g kg^{-1} for humidity. The results for 62 samples are shown as scatter plots in Figs. 37 and 38; means are summarized in the table of mean values and standard deviations of differences given below:

	Mean ETL	Mean Ship	Mean Psy	Ensemble	$\sigma_{\text{ETL-ship}}$	$\sigma_{\text{ETL-Pshch}}$
$T_{\text{air}} (\text{C})$	17.51	17.32	17.54	17.45	0.03	0.15
$Q_{\text{air}} (\text{g kg}^{-1})$	9.00	8.96	8.89	8.95	0.05	0.21

The differences in humidity (0.04 g kg^{-1}) in ETL and ship values are too small to be resolved by the psychrometer (accurate on average to 0.1°C and 0.1 g kg^{-1}). For

temperature, the psychrometer agrees with the ETL sensor. All three sensors are within required accuracy (0.2 C or g kg^{-1}) of the ensemble mean.

E. ETL Data Cruise Archive

Selected data products and some raw data were made available at the end of the cruise for the joint cruise archive. Some systems (radar, turbulence, microwave radiometer) generate too extravagantly to be practical to share. Compared to processed information, the raw data is of little use for most people. For the cloud radar we have made available image files only; full digital data will be available later from the ETL website. For the microwave radiometers, the time series is shared after some processing and averaging. No direct turbulent flux information is provided; that will be available after re-processing is done back in Boulder. However, bulk fluxes are available in the flux summary file

1. Data Archive Directories

Ceilo	Ceilmeter files (processed file, images)
Flux	Air-sea flux files (processed flux files: daily files, cruise file, some m-files)
Sondes	Rawindsonde files (.EDT, .PTU, .WND)
Aerosol	Time series of aerosol concentration at different sizes
Microwv	Microwave radiometer files (processed files; graphic display)
X-Radar	Image files from U. Miami X-band cloud radar
Reports	Documentation (cruise report, summary image files)
UProf	Image and data files from the wind profiler
Pics	Powerpoint files of sky pictures

Contact:

C. Fairall

NOAA Environmental Technology Laboratory

325 Broadway

Boulder, CO USA 80305

303-497-3253

chris.fairall@noaa.gov

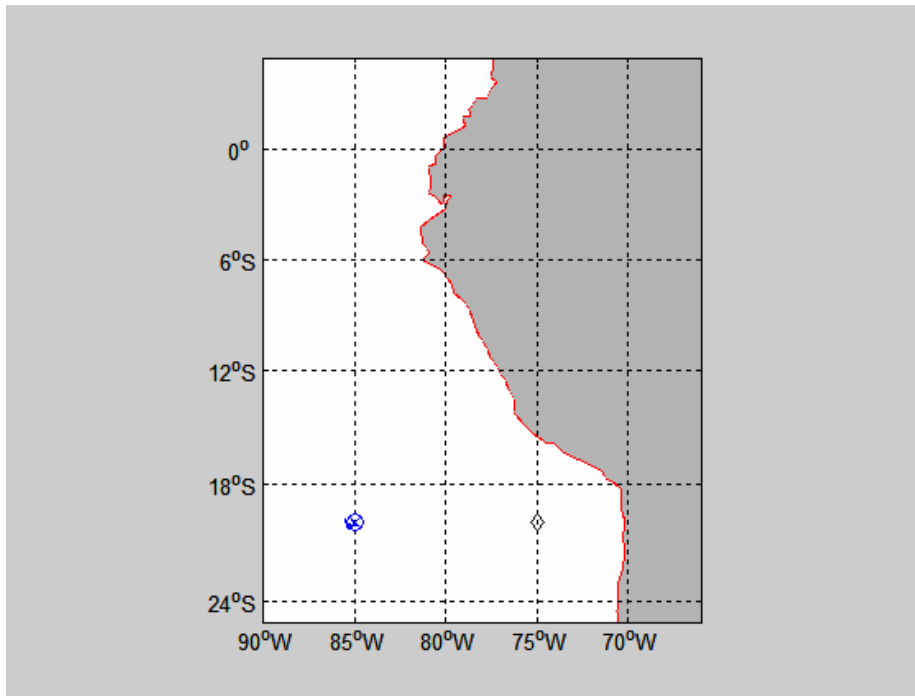

Figure 10. Cruise track for RBH on October 13 (DOY 286). The x marks the WHOI buoy location; the diamond is the DART buoy.

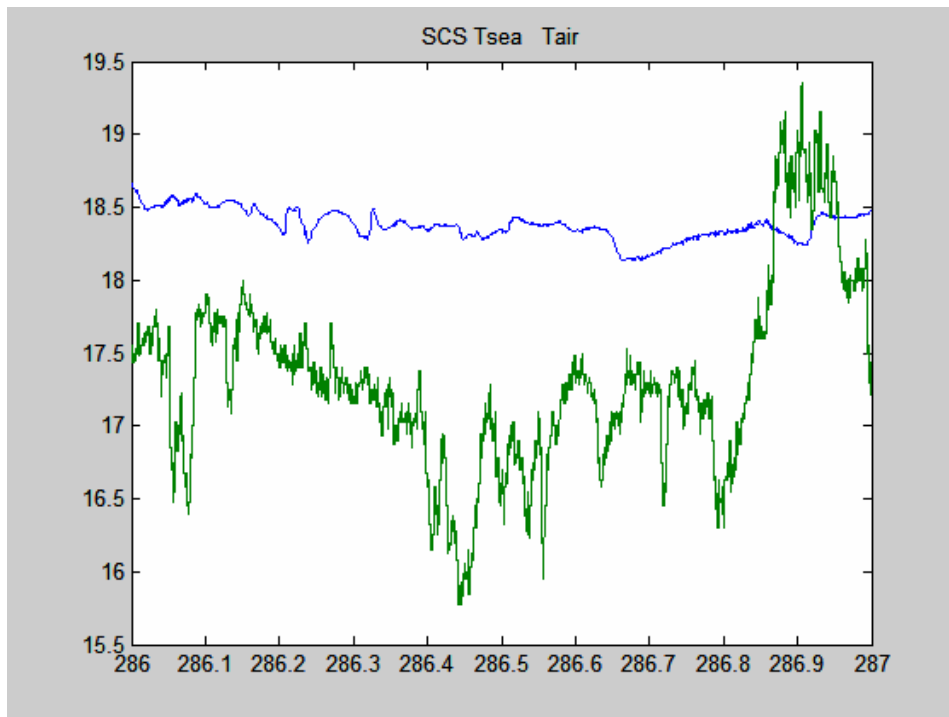

Figure 11. Time series of near-surface ocean temperature (green) and 15-m air temperature (blue).

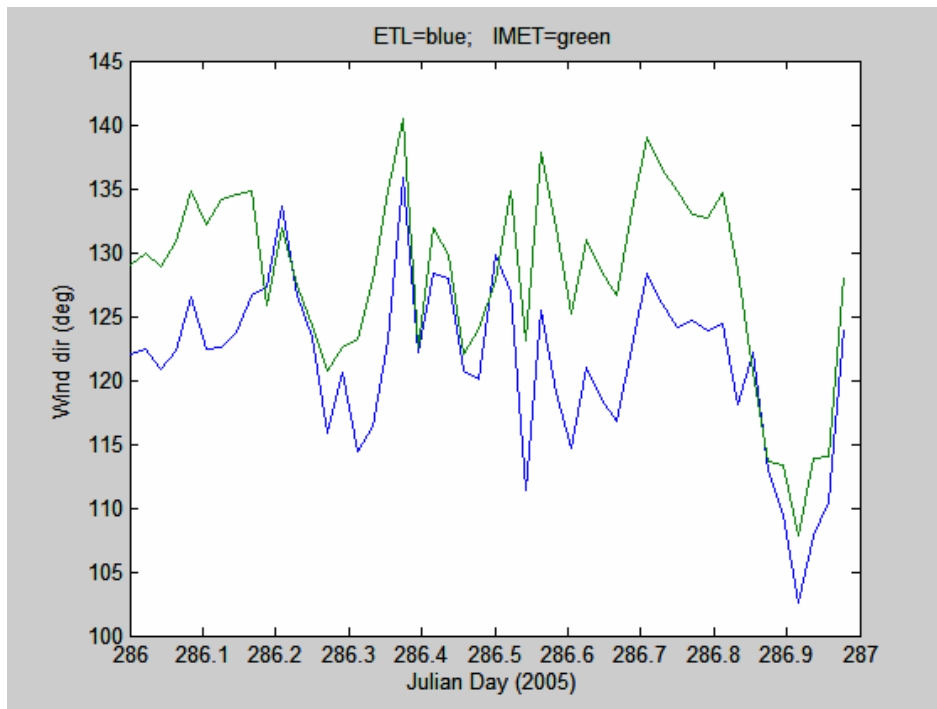

Figure 12. True wind direction from the ETL sonic anemometer (18 m) and the IMET propvane (15 m).

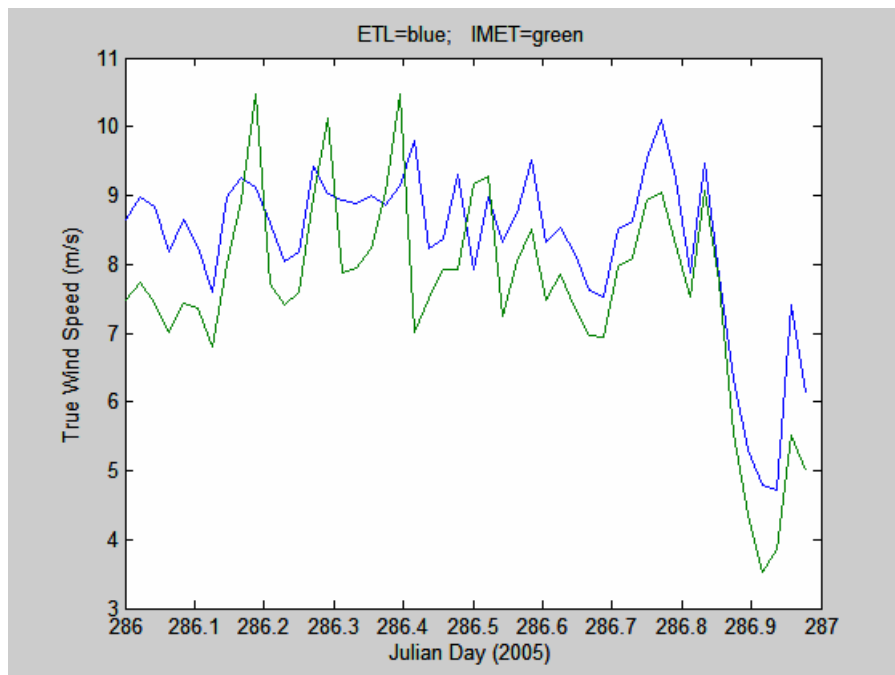

Figure 13. True wind speed from the ETL sonic anemometer (18 m) and the ship's propvane (15 m).

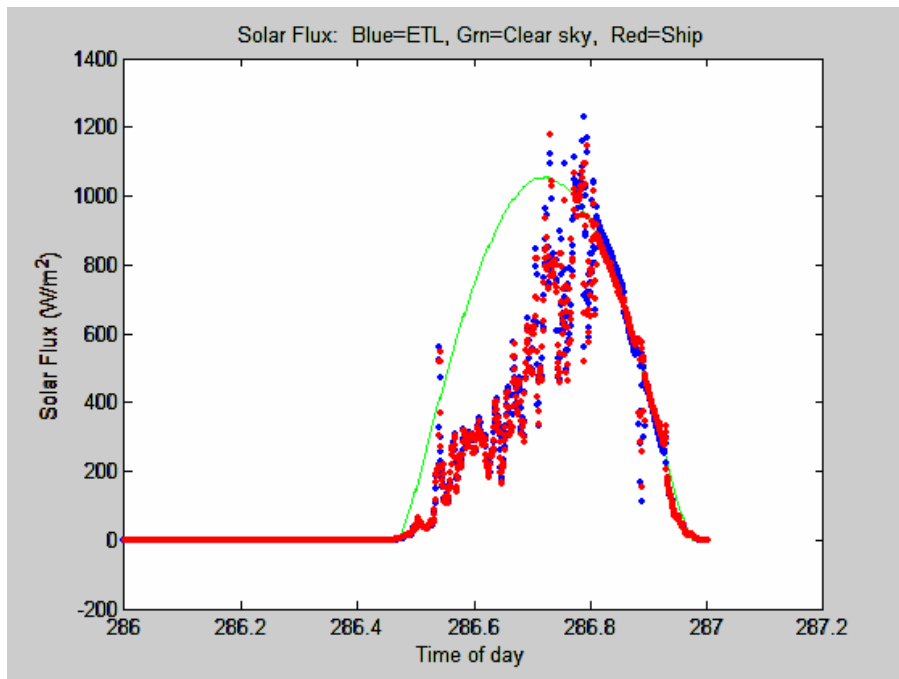

Figure 14. Time series of downward solar flux from ETL and ship Eppey sensors. The green line is a model of the expected clear sky value.

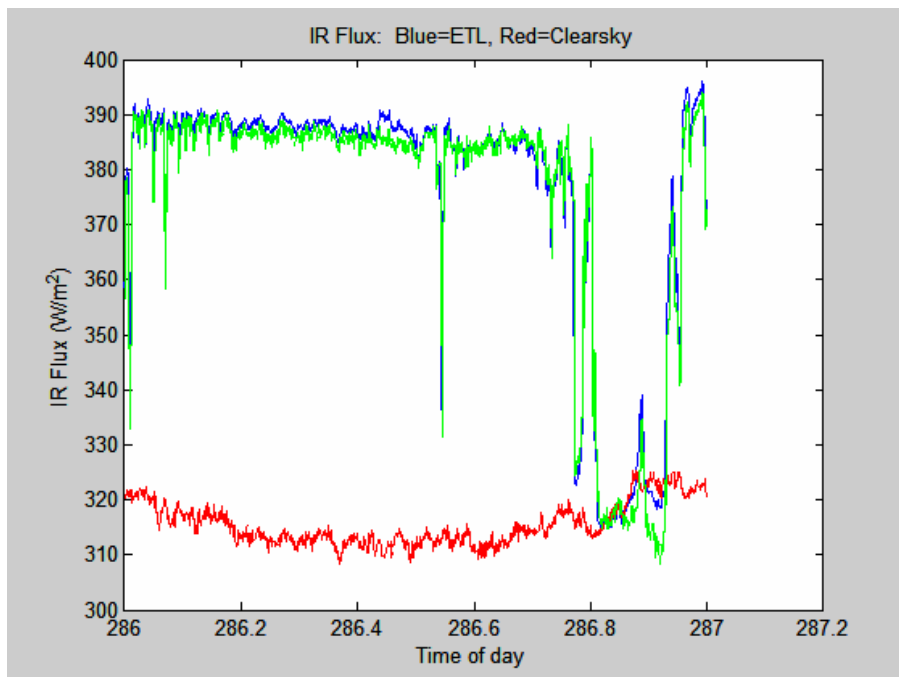

Figure 15. Time series of downward IR flux from ETL and ship Eppey sensors. The red line is a model of the expected clear sky value.

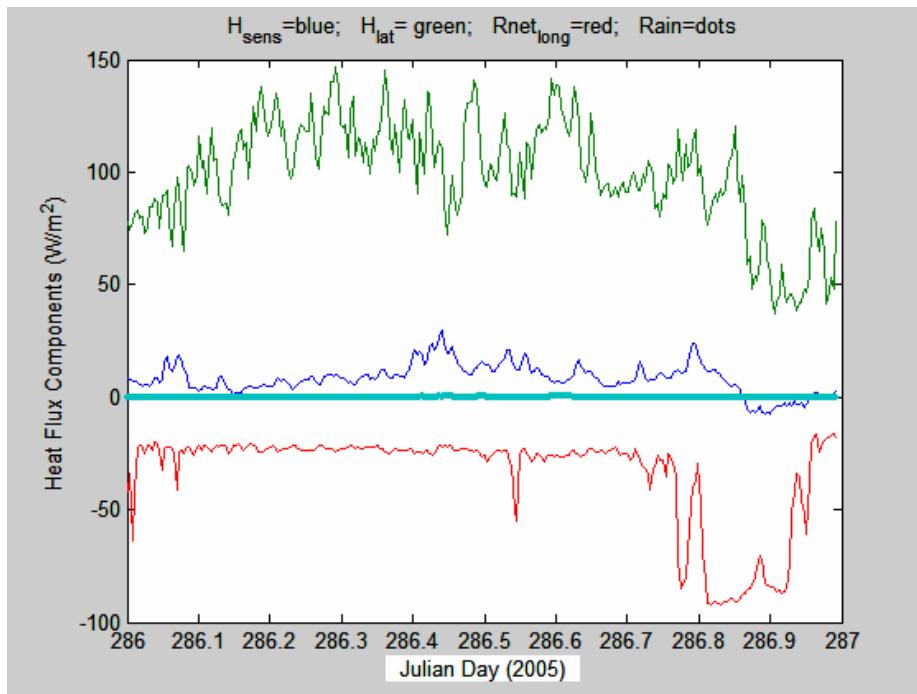

Figure 16. Time series of non-solar surface heat flux components: sensible (blue), latent (green), and net IR (red).

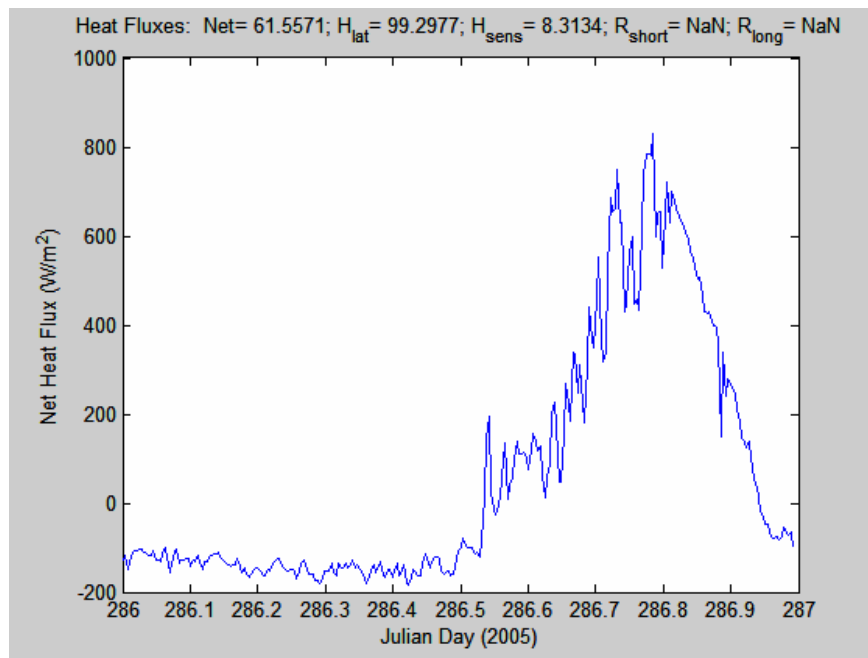

Figure 17. Time series of net heat flux to the ocean surface. The values at the top of the graph are the average for the day for each component of the flux.

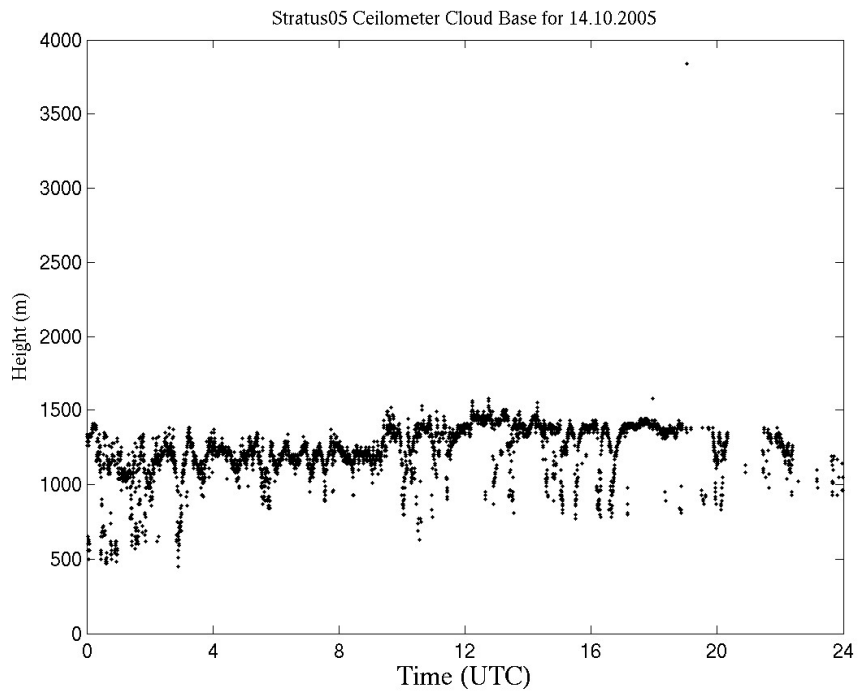

Figure 18. Cloud-base height information extracted from the ceilometer backscatter data for day 287 (October 14, 2005).

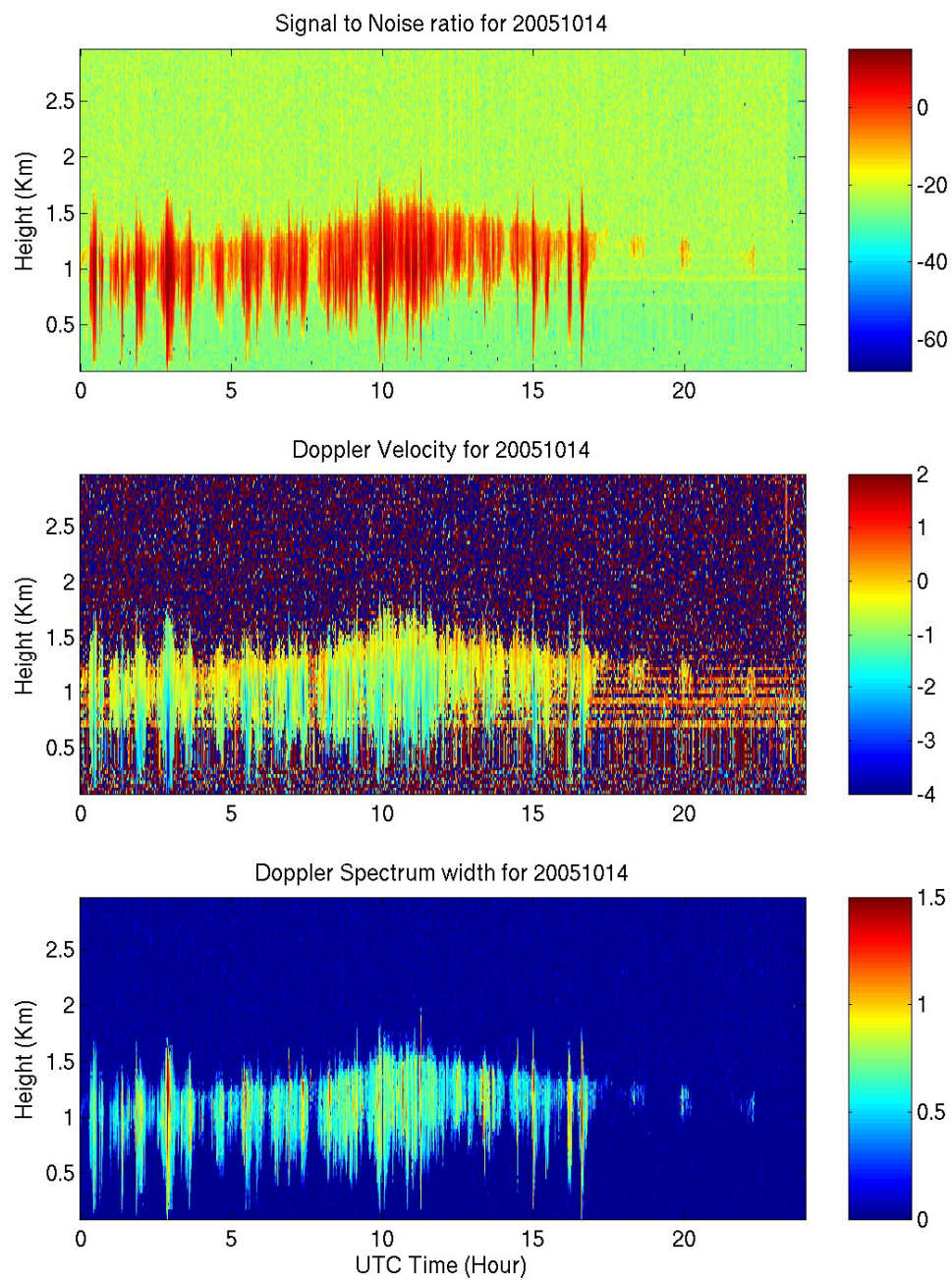

Figure 19. Time-height cross section data from 9.4 GHz cloud radar data for day 287 (October 14, 2005): upper panel, backscatter intensity; middle panel, mean Doppler vertical velocity; lower panel, Doppler width. The deep vertical streaks are drizzle.

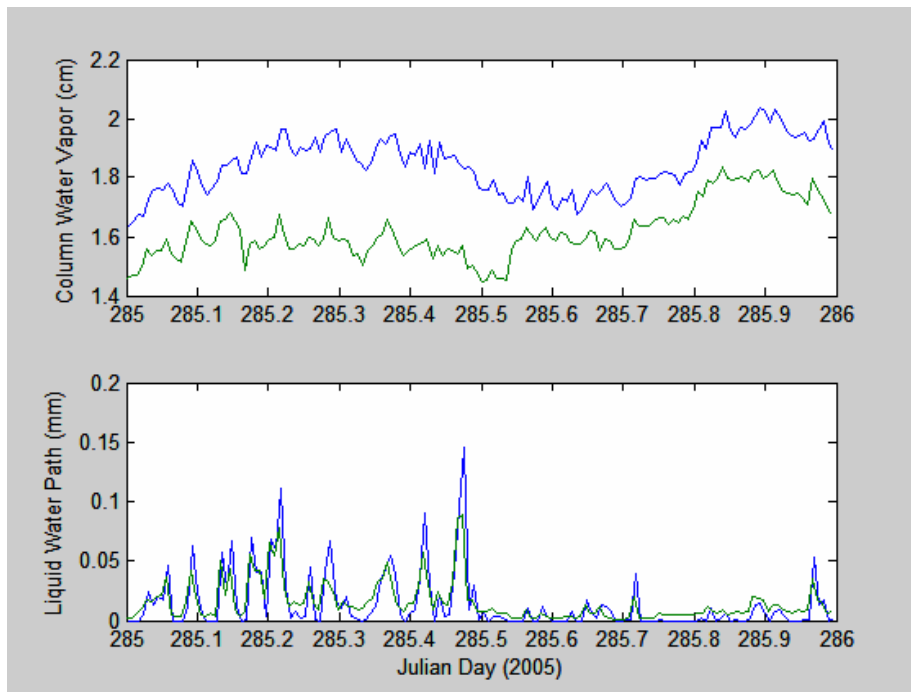

Figure 20. Time series of data from both the *new* and the *old* Radiometrics microwave radiometers: upper panel – column water vapor, lower panel – column water liquid. Note, new radiometer liquid water was divided by 10.

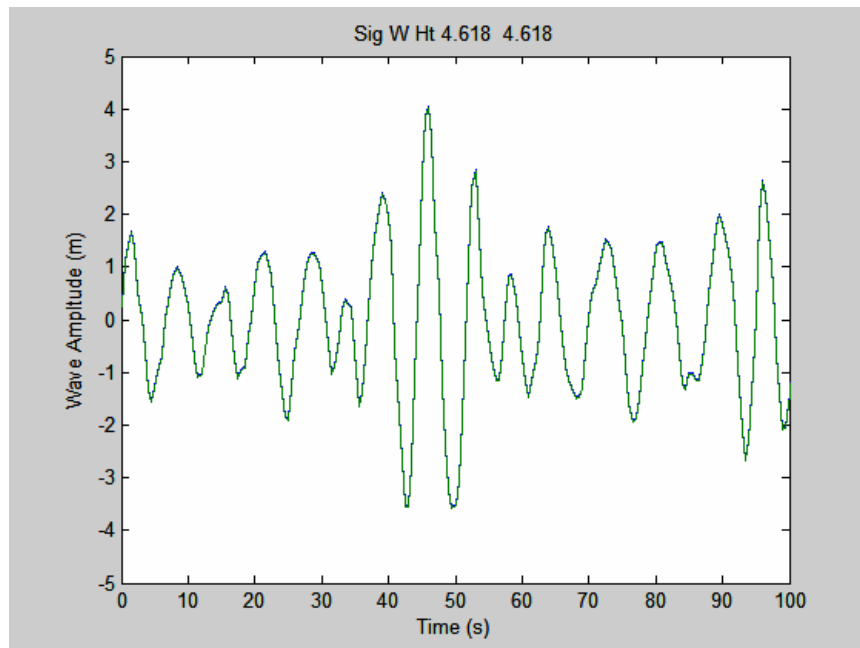

Figure 21. Sample wave time series from 1000 UTC on day 286 (October 13) from the laser rangefinder. The trace shows elevation of the sea surface relative to the bow of the ship. The dominant wave period is about 6 seconds.

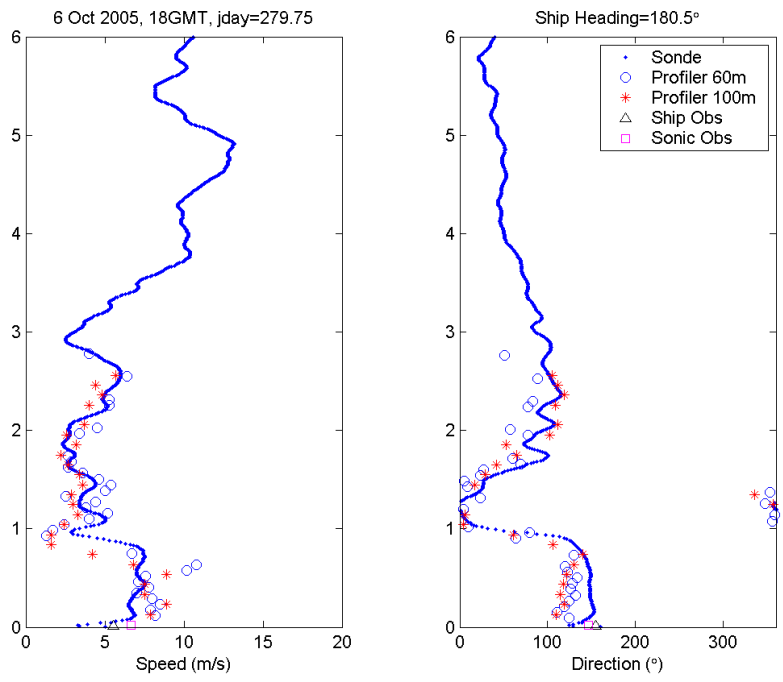

Figure 22. Wind speed and direction comparison of the wind profiler and the rawinsonde launched 18 Z October 6, 2005.

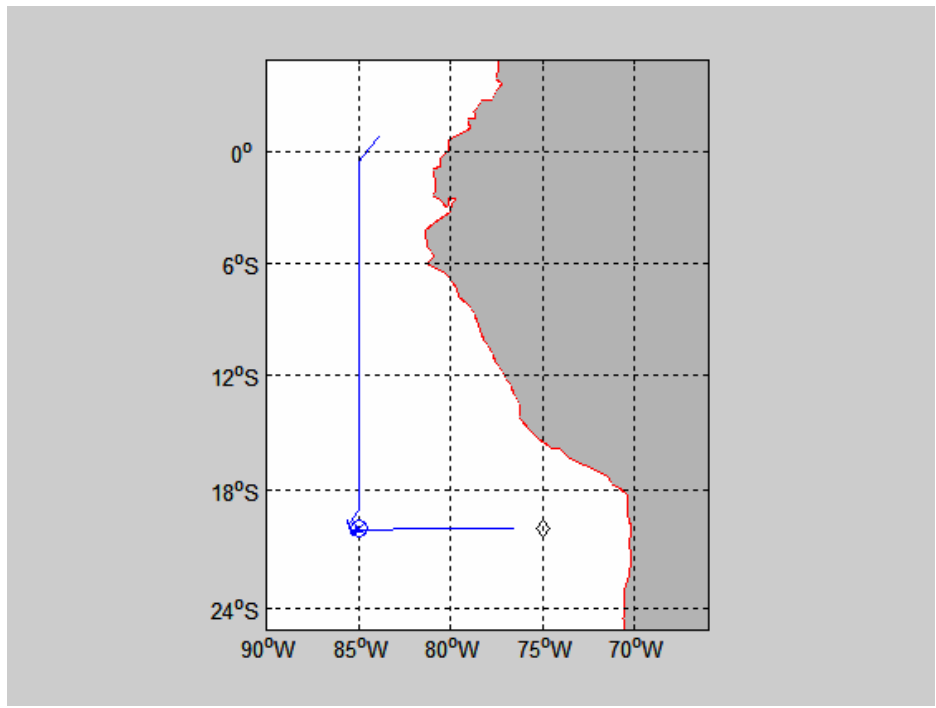

Figure 23. Cruise track for entire Stratus 2005 cruise.

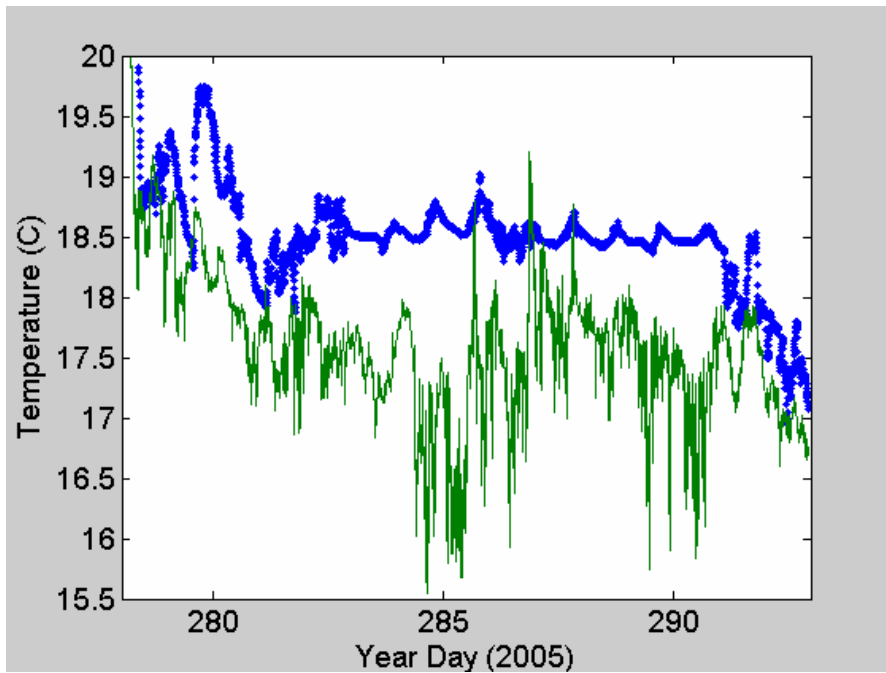

Figure 24. Time series of near-surface ocean temperature (blue) and 15-m air temperature (green) for the 2005 RHB Stratus cruise.

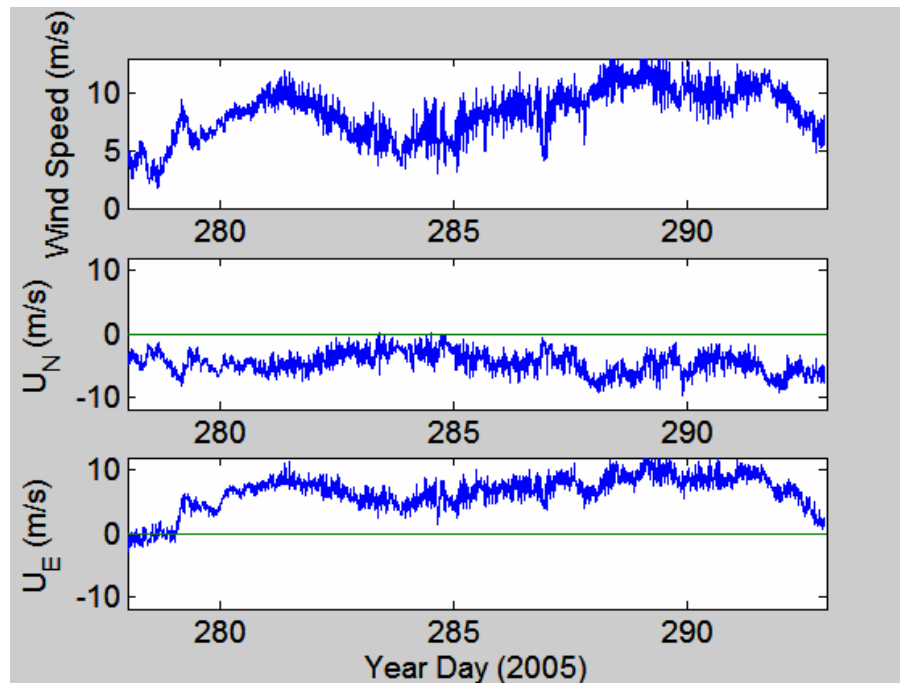

Figure 25. Time series of wind speed (upper panel), northerly component (middle panel), and easterly component (lower panel) for the 2005 RHB Stratus cruise.

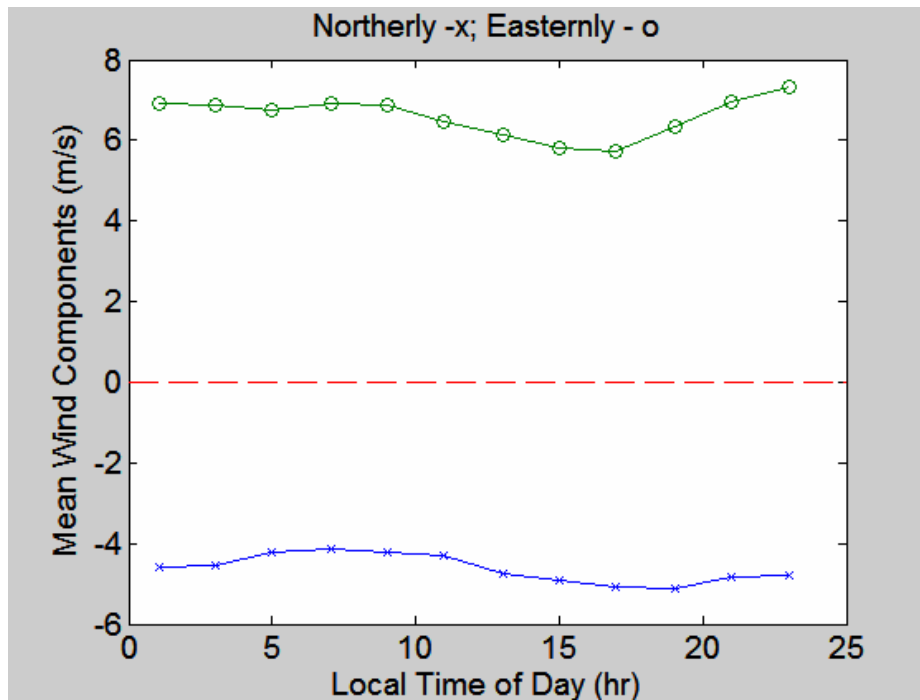

Figure 26. Diurnal average of northerly and easterly wind components for period near 20° S, 85° W.

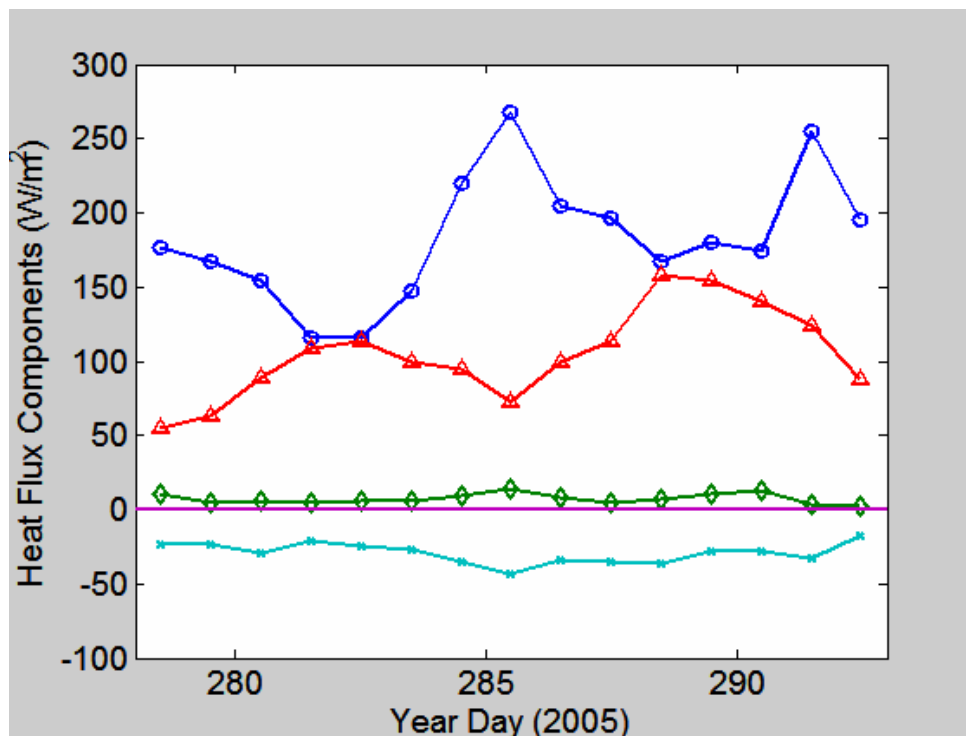

Figure 27. Time series of 24-hr average heat flux components: solar flux - circles; latent heat flux - triangles; sensible heat flux - diamonds; net IR flux x's.

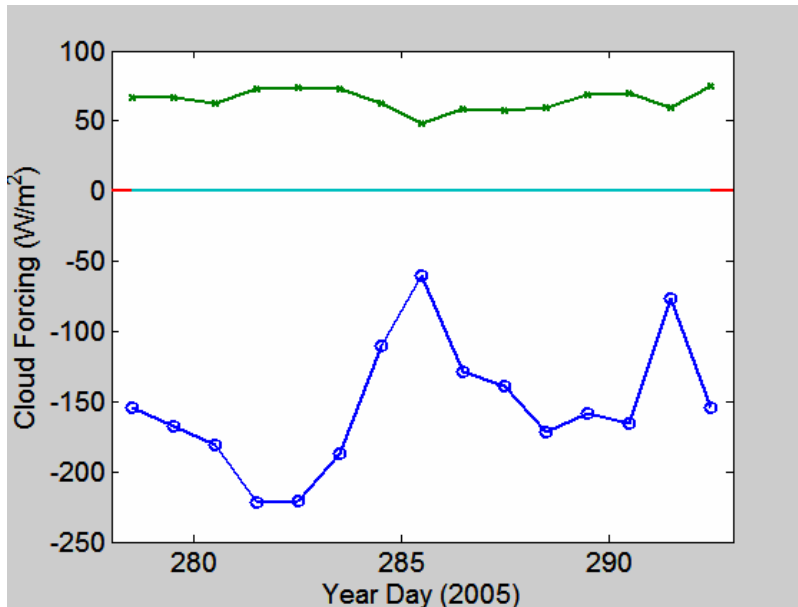

Figure 28. Time series of daily averaged radiative cloud forcing: IR CF (Wm^{-2}) – green, Solar CF (Wm^{-2}) – blue.

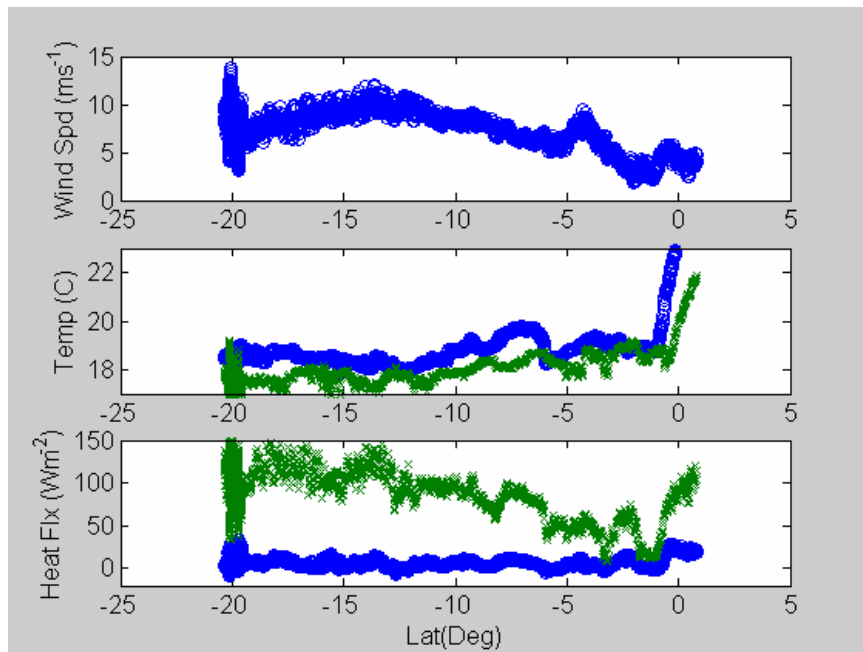

Figure 29. Selected variables from the N-S transect along 85° W. Upper panel is wind speed; the middle panel is sea surface temperature (blue) and air temperature (green); the lower panel shows sensible (blue) and latent (green) heat fluxes.

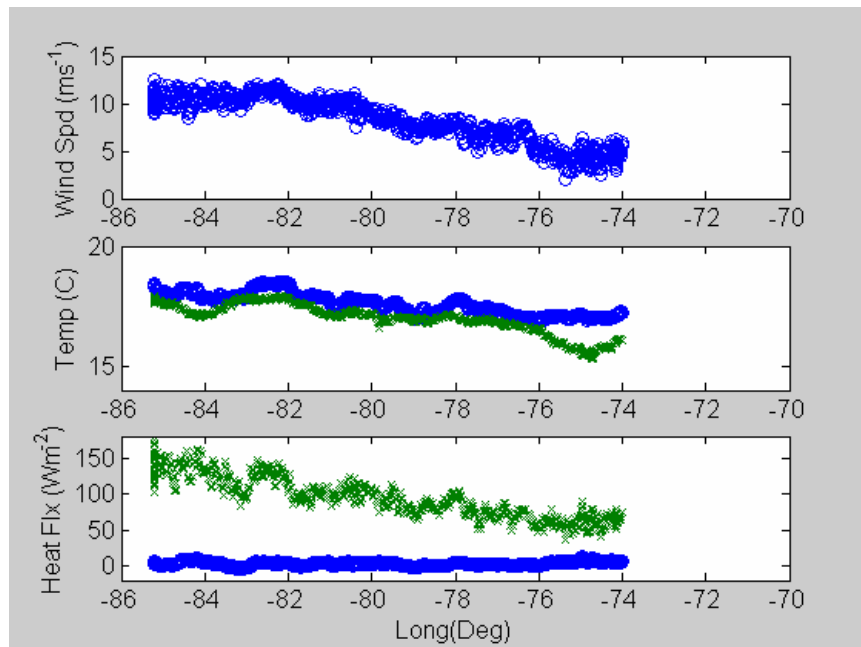

Figure 30. Same as Figure 20, but for the W-E transect along 20° S from 85° W to 70° W.

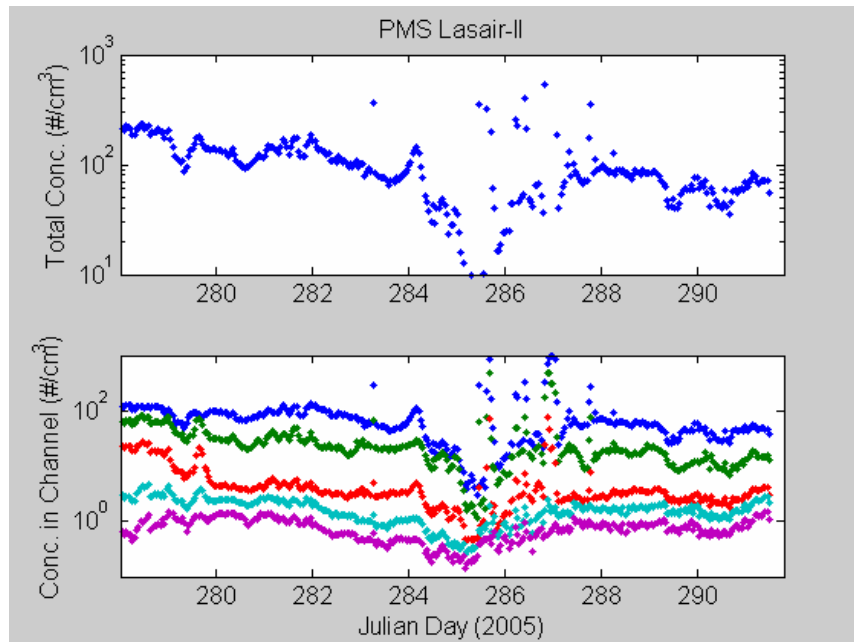

Figure 31. Aerosol concentrations from Lasair-II spectrometer. Upper panel: total number concentration for aerosols larger than 0.1 micron diameter. Lower panel: aerosol concentrations for 0.1-0.2 (blue), 0.2-0.3 (green), 0.3-0.5 (red), 0.5-1.0 (cyan), and 1.0-5.0 (magenta). Spikes are caused by the ship's exhaust.

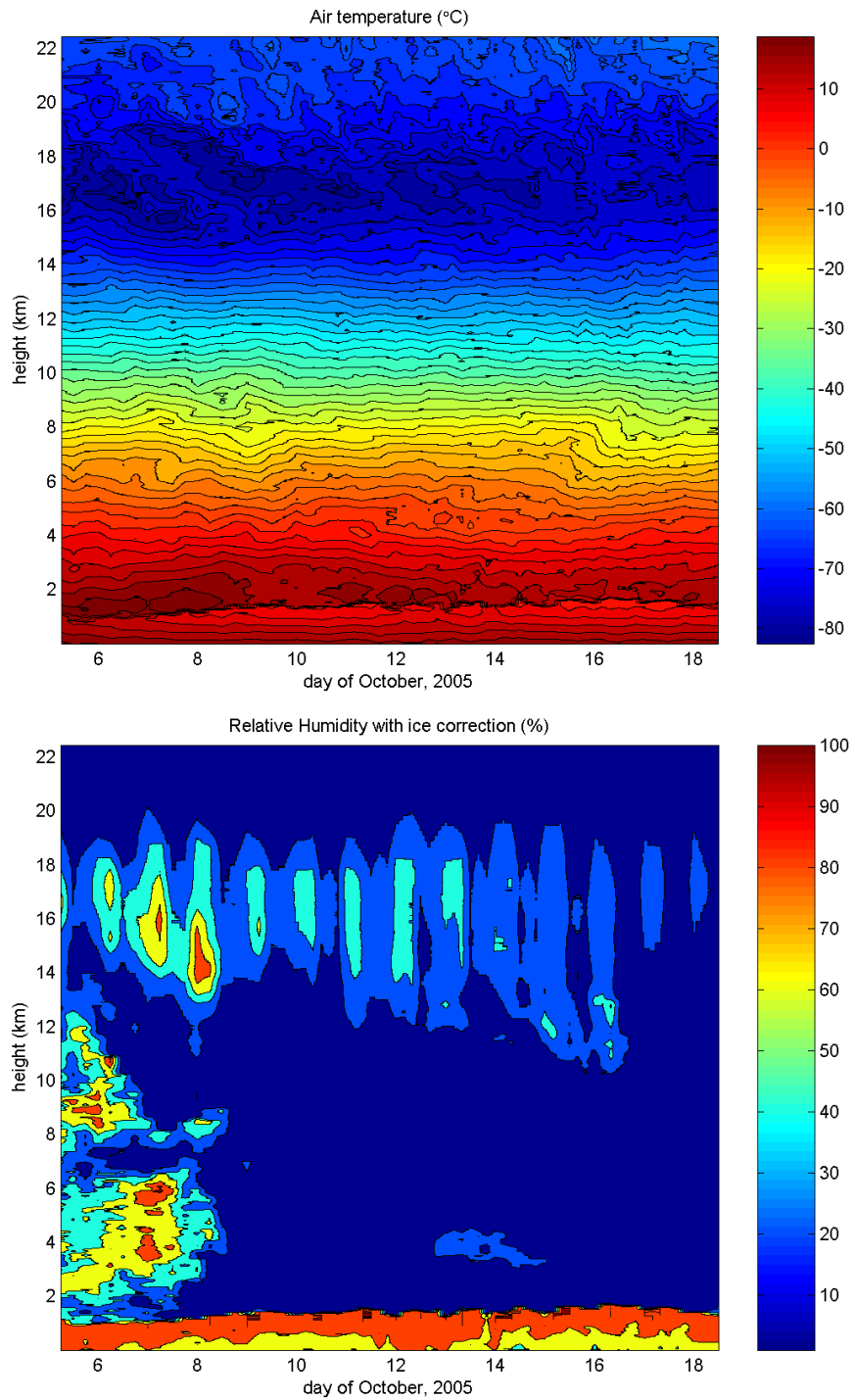

Figure 32. Time-height color contour plots from rawinsondes launched during the 2005 stratus cruise. The upper panel is temperature; the lower panel is relative humidity.

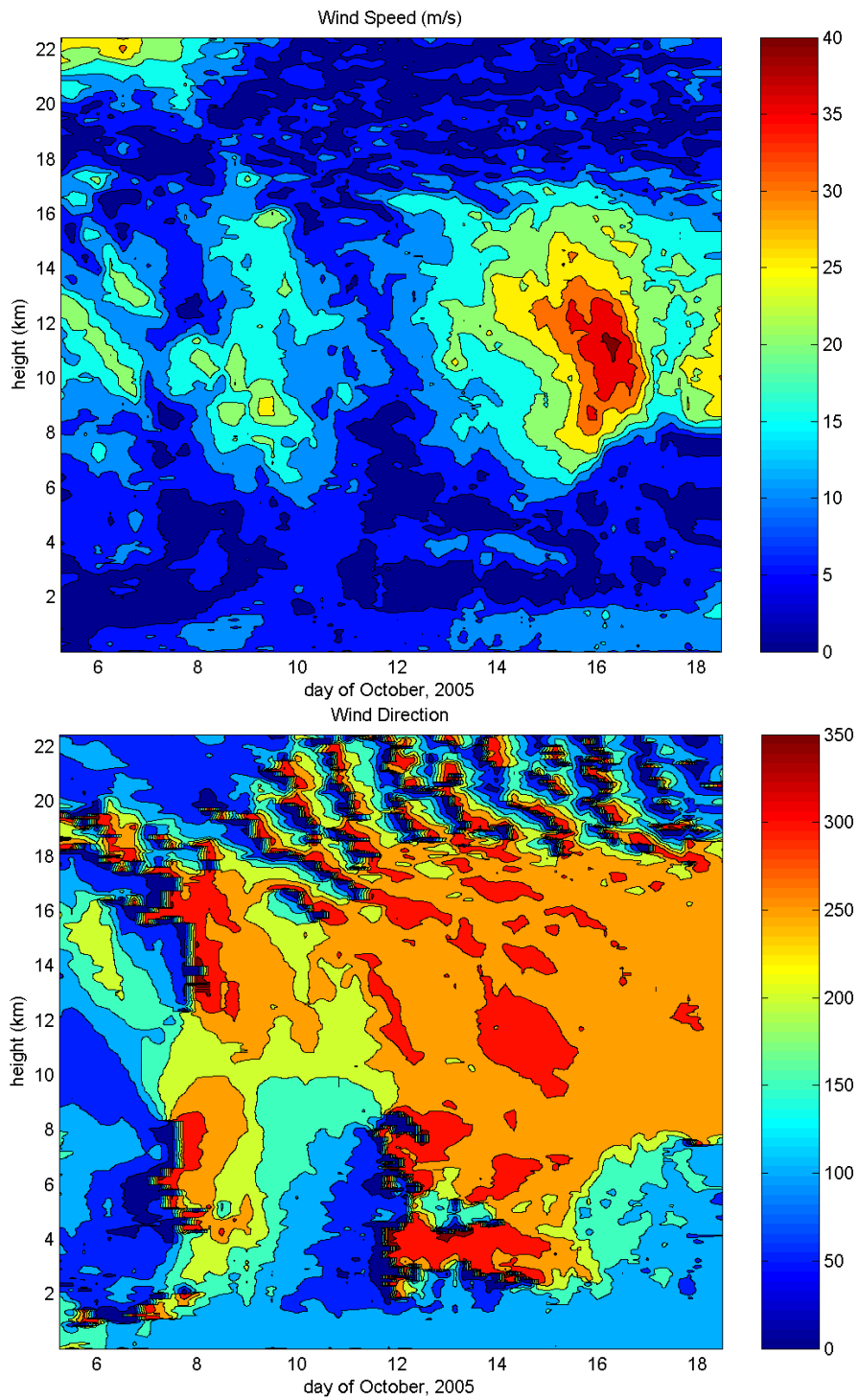

Figure 33. Time-height color contour plots from rawinsondes launched during the 2005 Stratus cruise. The upper panel is wind speed; the lower panel is wind direction.

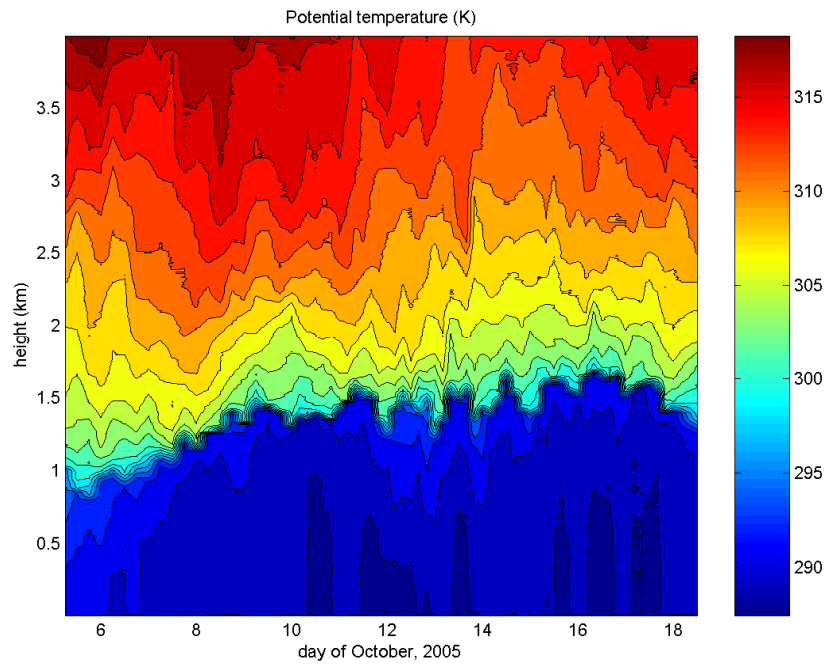

Figure 34. Time-height color contour plots of potential temperature from rawinsondes launched during the 2005 Stratus cruise. This height scale emphasizes the atmospheric boundary layer.

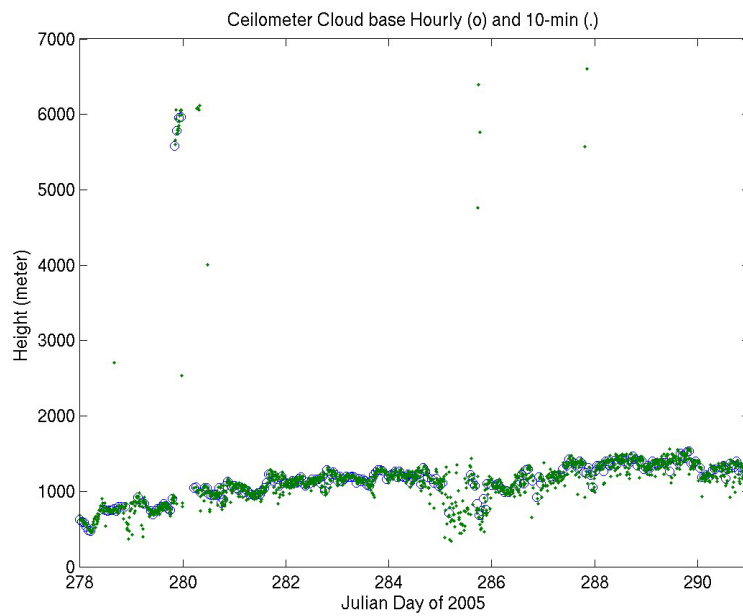

Figure 35. Time series of low cloud-base heights for the experimental period during October.

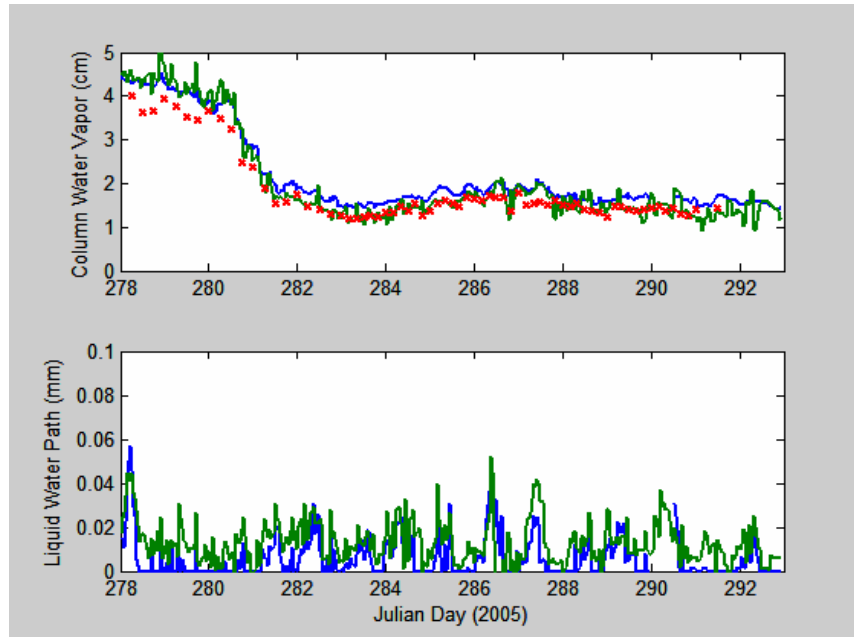

Figure 36. Time series of microwave radiometer-derived values for column integrated water vapor (upper panel) and column integrated liquid water (lower panel). Old mailbox=green, new mailbox=blue, and integrals from rawinsonde profiles=red x's (upper panel only).

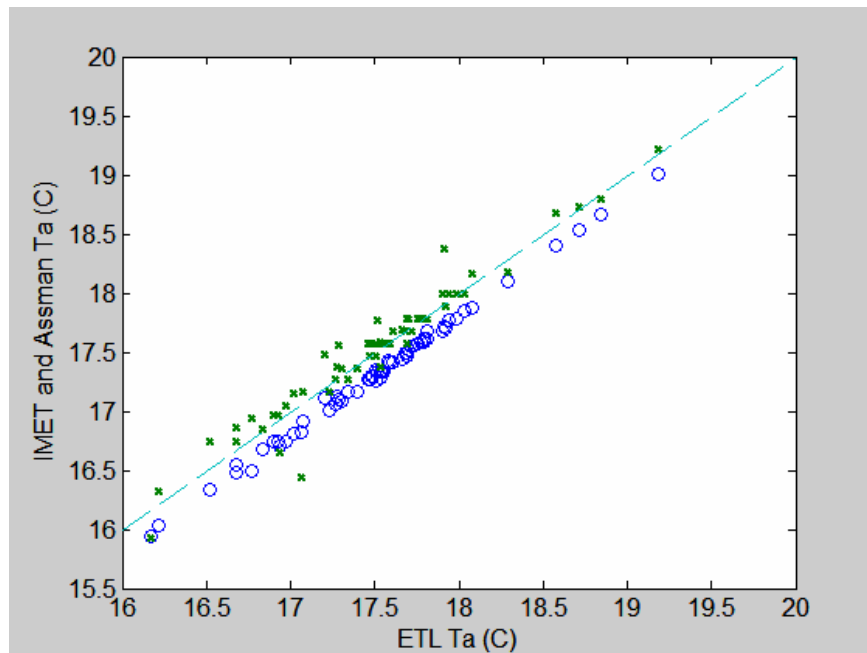

Figure 37. Comparison of simultaneous Assman psychrometer (x's) and ship (circles) readings for air temperature. Psychrometer values corrected to 15 m (ETL and ship instrument height).

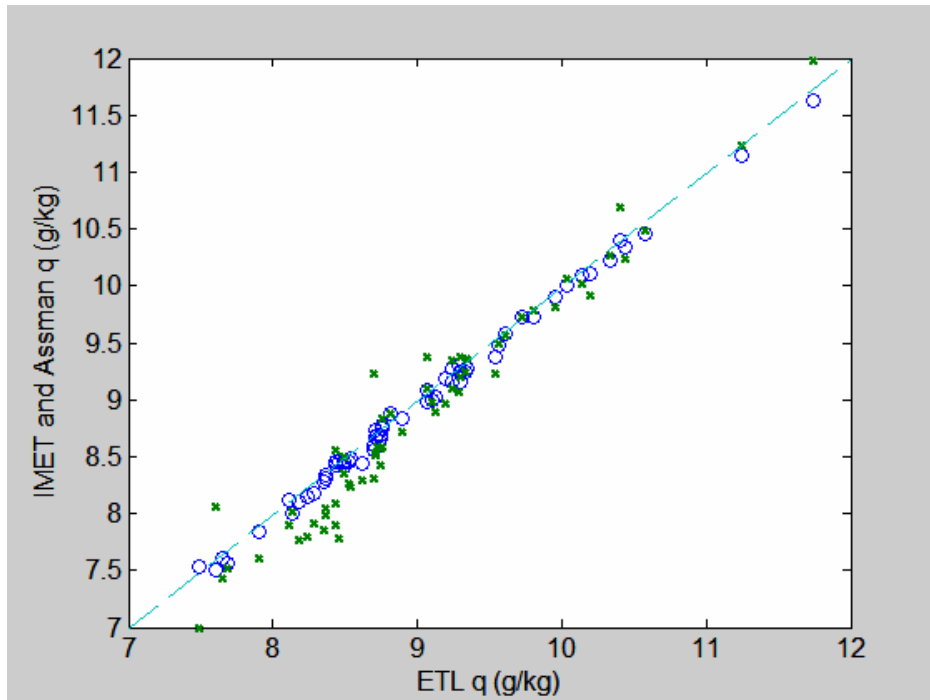

Figure 38. Comparison of simultaneous Assman psychrometer (x's) and ship (circles) readings for specific humidity. Psychrometer values corrected to 15 m (ETL and ship instrument height).

V. INSTRUMENT INTERCOMPARISONS

During the cruise, several types of data were collected for comparison and validation of the Stratus 5 and 6 data. CTD's were conducted near each buoy while it was in the water, for comparison with subsurface instruments. Comparisons were also made between the ship's IMET system and the buoys, and between the ETL systems and the buoys. The following sections give an overview of these comparisons. Further analysis will be done when the Stratus 5 and 6 data is processed.

A. CTD Casts

Four CTD casts were conducted during the cruise. Two were done near the Stratus 5 mooring prior to recovery, and two were done near the Stratus 6 mooring after it was deployed. Table 17 gives times and locations, and Figures 39–42 show the raw results of the casts.

Table 17: Stratus 2004 cruise CTD depths, times and locations

Start Time in Water (UTC)	Start Position	Wire Out (m)	Position at Depth	Stop Time (UTC)	Stop Position	Raw Filename
Oct. 9, 2005, 23:22	19° 47.523' S 085° 29.794' W	4400	19° 47.527' S 85° 29.794' W	Oct. 10, 2005, 02:37	19° 47. 531' S 85° 29.788' W	STRATUS6_CTD_2361_01.HEX
Oct.10, 2005, 03:14	19° 47.540' S 85° 29.793' W	4200	19° 47.542' S 85° 29.793' W	Oct. 10, 2005, 05:47	19° 47.538' S 85° 29.793' W	STRATUS6_CTD_2361_02.HEX
Oct. 14, 2005, 22:06	20° 6.344' S 85° 14.884' W	4000	20° 6.346' S 85° 14.893' W	Oct. 15, 2005, 00:28	20° 6.338' S 85° 14.889' W	STRATUS6_CTD_2361_03.HEX
Oct. 15, 2005, 03:26	20° 6.022' S 85° 14.851' W	4000	20° 6.036' S 85° 14.859' W	Oct. 15, 2005, 05:45	20° 6.016' S 85° 14.849' W	STRATUS6_CTD_2361_04.HEX

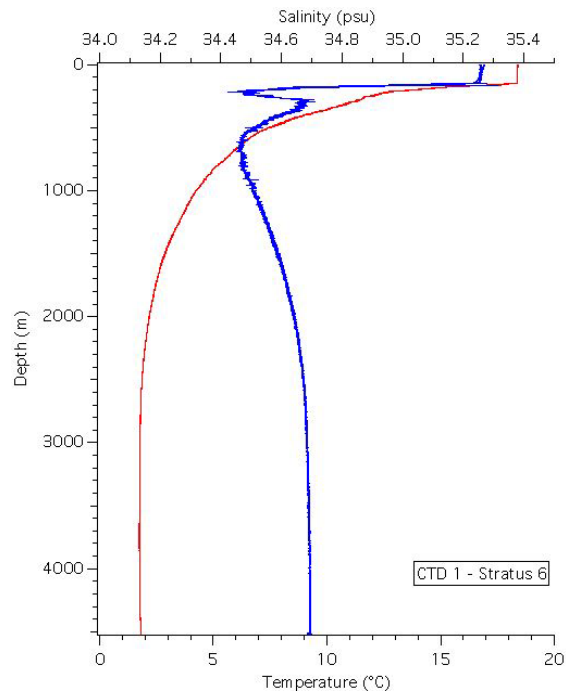

Figure 39. CTD cast 1 results. Red line is temperature; blue line is salinity.

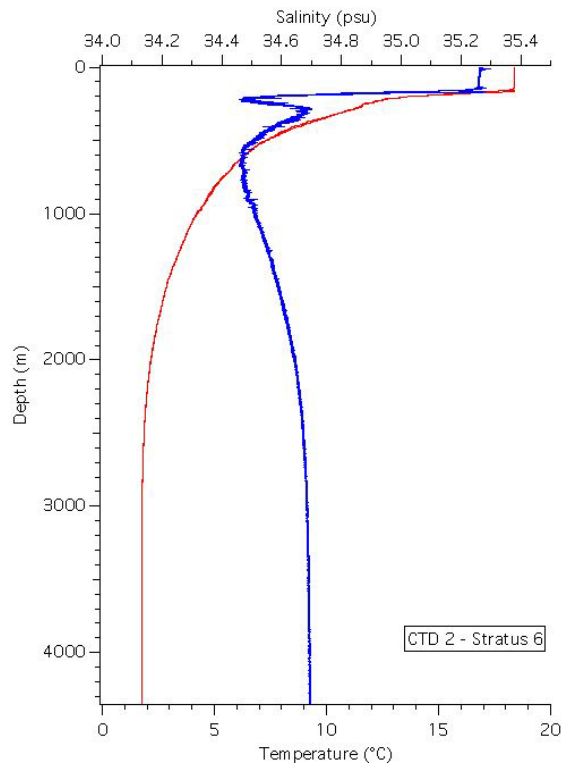

Figure 40. CTD cast 2 results. Red line is temperature; blue line is salinity.

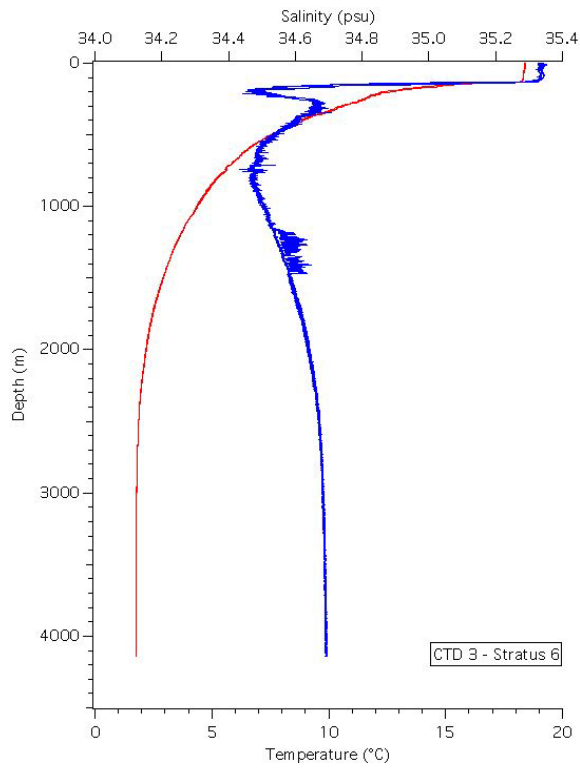

Figure 41. CTD cast 3 results. Red line is temperature; blue line is salinity.

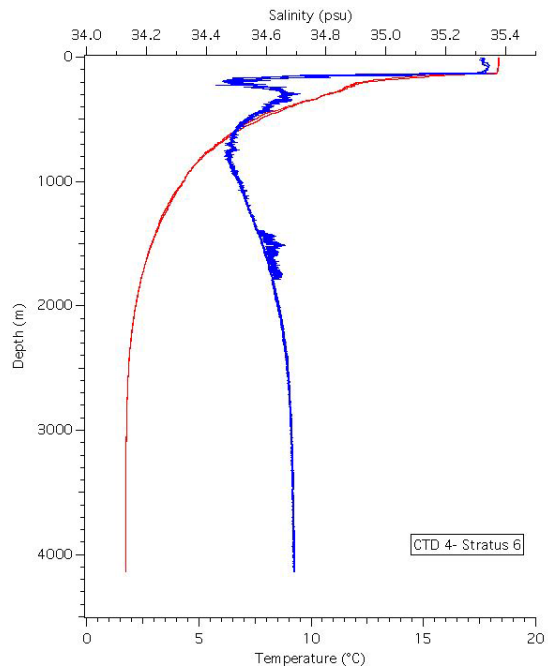

Figure 42. CTD cast 4 results. Red line is temperature; blue line is salinity.

B. Ship to Buoy IMET Comparisons.

During the cruise, shipboard IMET data was overplotted with buoy IMET data in real time. The shipboard data was collected through the ship's Scientific Computer System (SCS) every minute. The buoy IMET data was collected using an Alpha Omega antenna to receive the hourly averaged data the buoy transmits through the Argos satellite system.

The figures below show the shipboard data compared to the Stratus 5 and 6 data while these moorings were in the water. As seen in the air temperature and humidity plots, one module on Stratus 5 failed during the year. There was no measurable rain during the intercomparison period. The rain plot shows that the Stratus 6 Logger 1 precipitation module had significant variability in rain level. This will be evaluated further upon recovery.

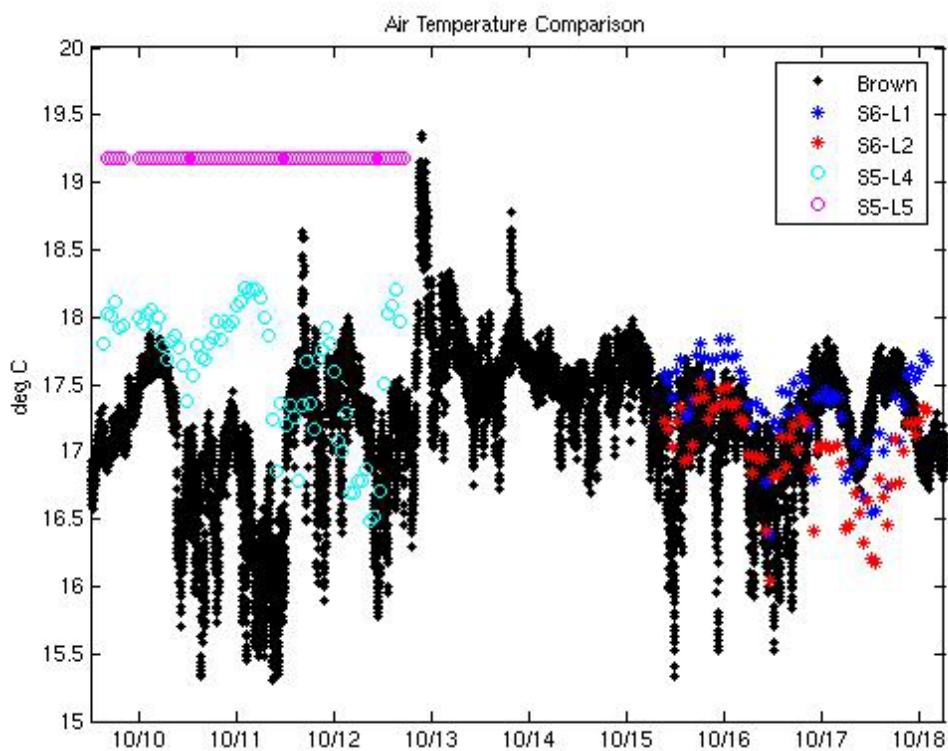

Figure 43. Ship-buoy air temperature comparison. S5 and S6 denote Stratus 5 and 6 respectively. Likewise, L# denotes the IMET logger number on each mooring. The following figures follow the same labeling scheme.

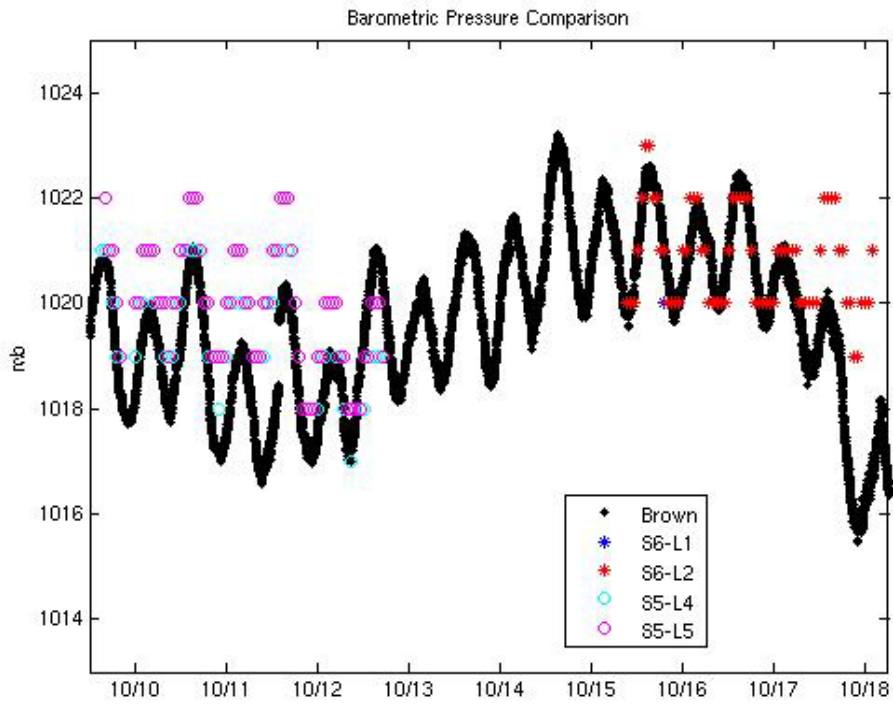

Figure 44. Ship-buoy barometric pressure comparison

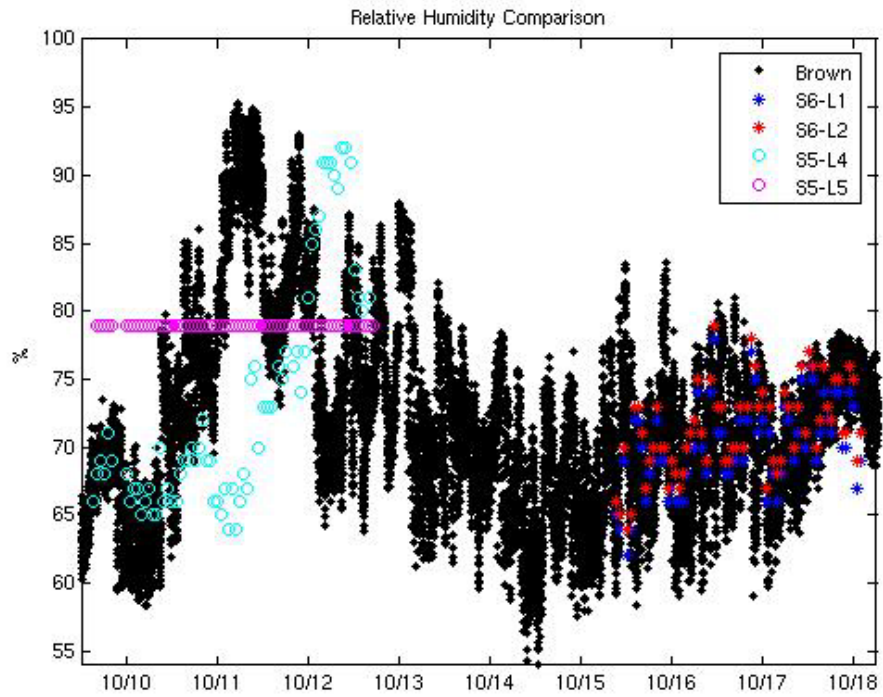

Figure 45. Ship-buoy relative humidity comparison

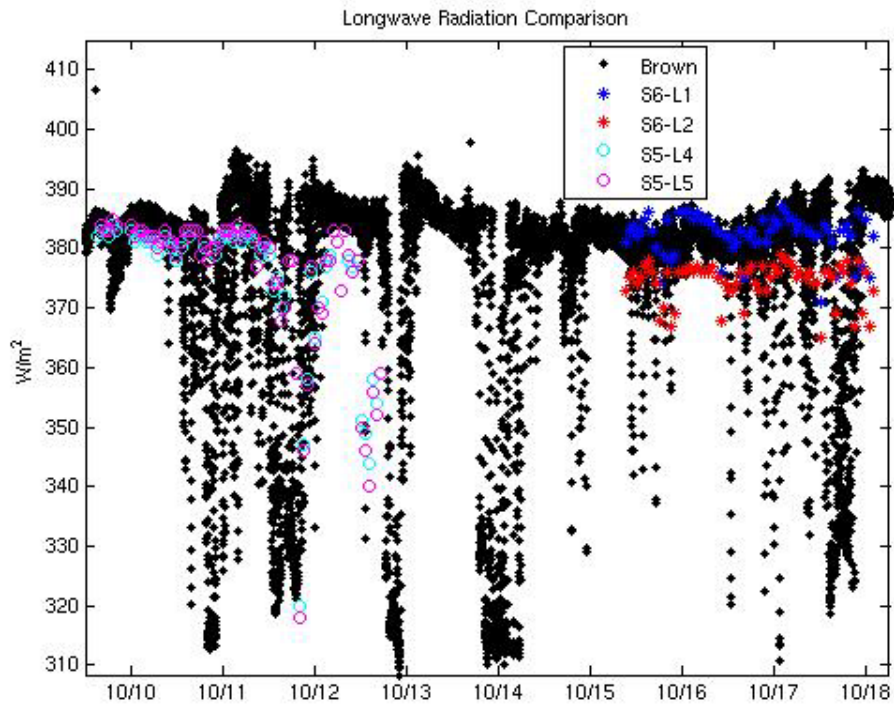

Figure 46. Ship-buoy air temperature comparison

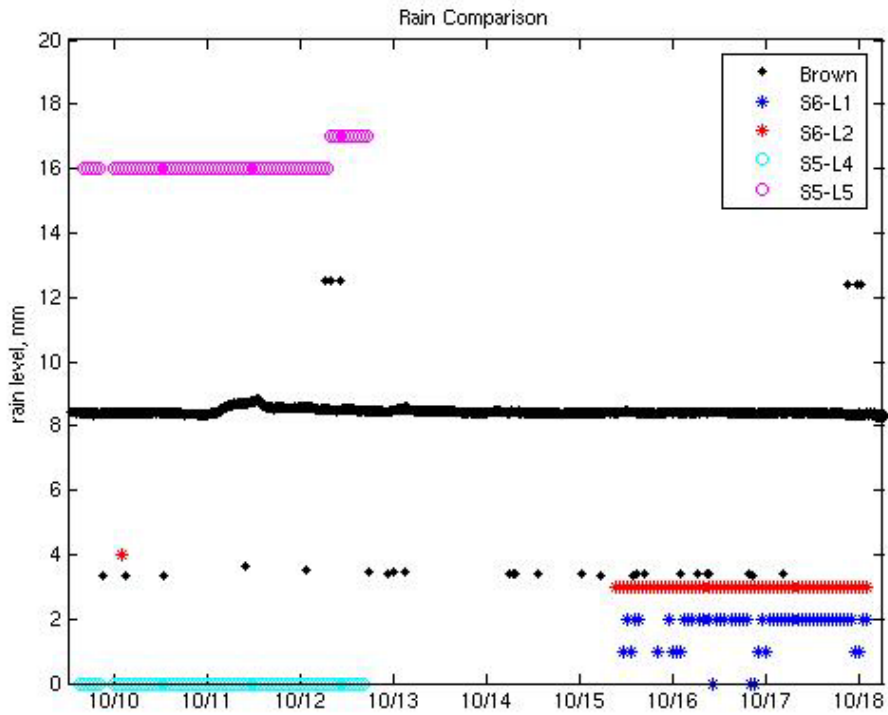

Figure 47. Ship-buoy air temperature comparison

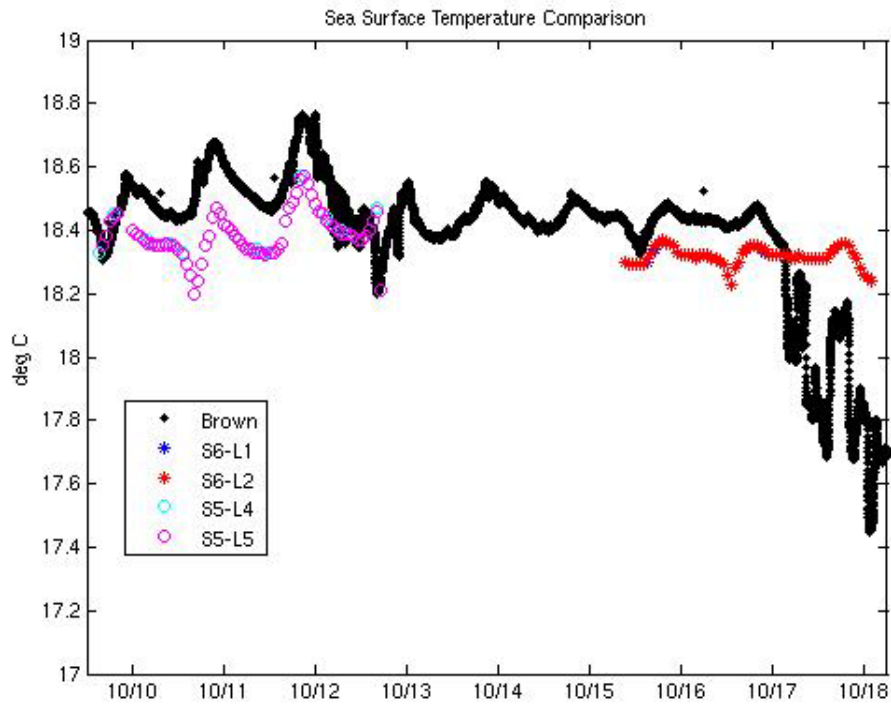

Figure 48. Ship-buoy sea surface temperature comparison

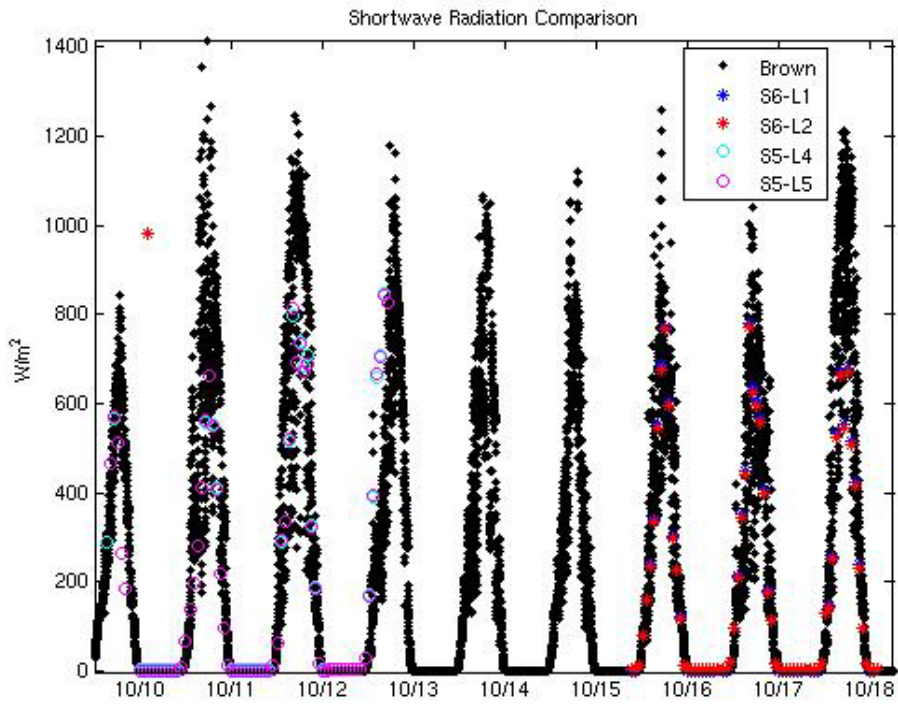

Figure 49. Ship-buoy shortwave radiation comparison

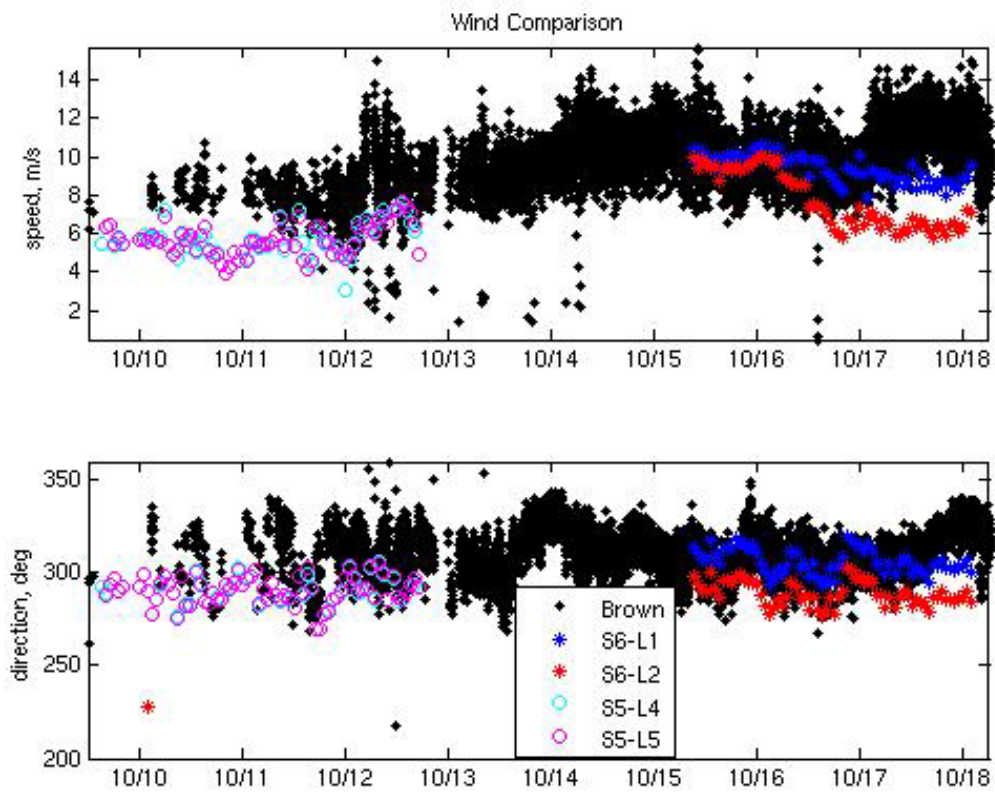

Figure 50. Ship-buoy wind comparison

C. ETL to Buoy Comparisons

ETL radiation data was shared with the UOP group so that the Stratus 5 and 6 IMET radiometer data could be validated. Figure 51 shows the preliminary results of these comparisons. The data shown in the plot, from October 10, 2005, was collected while Stratus 5 was in the water prior to recovery and Stratus 6 was on the fantail. Further comparisons of the ETL and Stratus data will be done during final data processing. The Stratus 6 Logger 1 longwave radiometer is notably offset, this will also be assessed when the mooring is recovered.

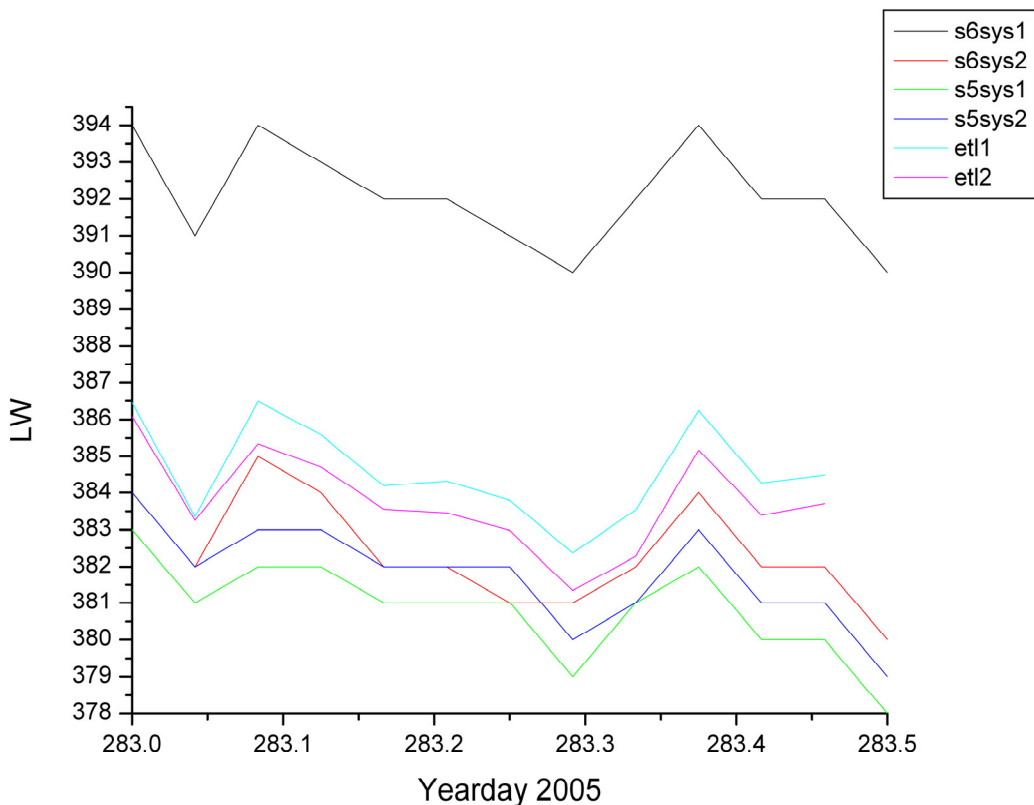

Figure 51. Comparison of ETL, Stratus 5, and Stratus 6 longwave radiometers.

VI. ADDITIONAL CRUISE ACTIVITIES

A. Deployment of Drifters and Underway Watch

During the Stratus 2005 cruise, a 24-hour watch schedule was set up. Watchstanders were responsible for updating the cruise log, deploying Argo floats and surface drifters, and assisting the ETL group with radiosonde deployments.

For more information on, and data from Argo floats, please visit the Argo website at <http://www.argo.net/>. The Global Drifter Program, also has a website that has information and data on their floats at <http://www.aoml.noaa.gov/phod/dac/gdp.html>.

The floats and drifters were deployed at specified locations. The ship was not stopped for deployments of the Argo floats or surface drifters. The exceptions were two Argo floats that needed to be removed from their cardboard containers and deployed at a slower speed of two knots. Deployment details are given below in Tables 18 and 19.

Table 18: Deployment times and locations for the Argo floats

Serial #	Self Test Time (UTC)	Deployment Time (UTC)	Location	Notes
505	October 2, 2005 23:13	October 5, 2005 10:23:00	0° 59.996' S 85° 0.080' W	
500	October 5, 2005 15:19	October 5, 2005 15:52	1° 59.776' S 85° 0.055' W	Box opened for deployment
469	October 6, 2005 08:02	October 6, 2005 08:23	5° 0.119' S 84° 58.481' W	
504	October 6, 2005 22:40	October 7, 2005 00:44	8° 0.138' S 85° 0.071' W	Box opened for deployment
507	October 8, 2005 22:20	October 8, 2005 23:10	16° 0.00' S 85° 0.00' W	
508	October 9, 2005 10:12	October 9, 2005 10:25	18° 0.652' S 85° 0.008' W	
501	October 9, 2005 09:50	October 20, 2005 01:20	20° 0.00' S 76° 0.00' W	Initial test was inconclusive, but was double checked and determined in working order.
506	October 20, 2005 01:30	October 20, 2005 06:00	20° 0.00' S 75° 0.00' W	

Table 19: Deployment times and locations for the surface drifters

ID #	Date	Time (UTC)	Location
54412	October 5, 2005	10:24	1° 00.116' S 85° 0.040' W
54170	October 5, 2005	15:55	1° 59.874' S 85° 0.053' W
54414	October 5, 2005	23:56	3° 30.2' S 85° 0.00' W
54411	October 6, 2005	08:22	4° 59.987' S 84° 58.484' W
54410	October 6, 2005	19:01	6° 59.449' S 84° 59.995' W
54406	October 7, 2005	06:21	8° 59.965' S 84° 59.998' W
54408	October 7, 2005	17:40	10° 59.861' S 84° 59.992' W
54405	October 7, 2005	23:27	12° 0.00' S 85° 0.00' W
54400	October 8, 2005	08:13	13° 30.004' S 85° 0.012' W
54413	October 8, 2005	17:12	14° 59.340' S 85° 0.006' W
54403	October 9, 2005	00:06	17° 0.006' S 85° 0.005' W
54407	October 9, 2005	10:27	18° 0.742' S 85° 0.009' W
54409	October 9, 2005	16:30	19° 0.05' S 85° 0.042' W
54402	October 18, 2005	14:22	20° 0.00' S 83° 0.23' W
54401	October 19, 2005	10:36	20° 0.003' S 79° 12.000' W
54404	October 20, 2005	09:51	19° 20.257' S 74° 35.482' W

B. University of Concepcion Research

The goal of this work, carried out by Carolina Cisternas and Rodrigo Castro, is to perform a biomarker and molecular biology survey for nitrogen fixers in the area between Panama and Arica, Chile.

During the transit leg from Panama to Arica, Chile, samples were collected from the ship's intake (5.6 m deep), and a few bucket samples for surface seawater calibration at the Stratus buoy site (20°03.17'S, 85°13.12'). Seawater was collected every ~60nm and filtered on 0.2 um and 0.7 um pore size filters for particulate organic matter for stable isotope (¹³C and ¹⁵N, 3 liters) analyses, organic biomarkers (3 liters), and NifH gene (0.5 liters). The locations and times of samples collected are given in Table 20.

Table 20. Location of water sampling stations.

Sample	Date (mm/dd)	Time (UTC)	Depth (m)	Lat.	Long.
1	10/04	21:55	3421	01° 10.66' N	83° 39.49' W
2	10/05	05:13	2879	00° 03.30' S	84° 38.32' W
3	10/05	10:25	3196	01° 00.13' S	85° 00.04' W
4	10/05	15:58	2625	02° 00.00' S	85° 00.46' W
5	10/05	21:13	3252	03° 00.01' S	85° 00.00' W
6	10/05	23:54	3388	03° 30.03' S	85° 00.04' W
7	10/06	02:42	3465	04° 00.00' S	84° 59.99' W
8	10/06	08:32	4033	05° 00.82' S	84° 58.68' W
9	10/06	13:42	4100	06° 00.03' S	85° 00.04' W
10	10/06	16:24	3997	06° 30.63' S	85° 00.01' W
11	10/06	19:04	4109	07° 00.04' S	84° 59.99' W
12	10/06	21:51	4352	07° 30.05' S	85° 00.00' W
13	10/07	00:41	4235	08° 00.00' S	85° 00.04' W
14	10/07	06:21	4417	09° 00.01' S	85° 00.00' W
15	10/07	12:03	4481	10° 00.03' S	84° 59.89' W
16	10/07	14:52	4535	10° 30.10' S	85° 00.01' W
17	10/07	17:40	4499	11° 00.07' S	84° 59.99' W
18	10/07	20:39	4336	11° 30.00' S	84° 59.99' W
19	10/07	23:27	4386	12° 00.16' S	85° 00.00' W
20	10/08	05:16	4810	13° 00.04' S	84° 59.99' W
21	10/08	11:17	4792	14° 00.03' S	85° 00.03' W
22	10/08	14:19	4696	14° 30.01' S	85° 00.02' W
23	10/08	17:16	4808	15° 00.02' S	85° 00.00' W
24	10/08	20:12	4758	15° 30.02' S	84° 59.98' W
25	10/08	23:12	4745	16° 00.01' S	85° 00.02' W
26	10/09	05:05	4671	17° 00.02' S	85° 00.00' W
27	10/09	11:01	4494	18° 01.28' S	85° 00.00' W
28	10/09	13:45	4525	18° 30.16' S	85° 00.03' W
29	10/09	16:31	4447	19° 00.00' S	85° 00.05' W
30	10/09	19:41	4447	19° 30.00' S	85° 20.09' W
31 (b)*	10/10	17:25	4458	19° 43.81' S	85° 33.29' W
32	10/10	17:33	4458	19° 43.83' S	85° 33.30' W
33 (b)	10/12	14:00	4467	19° 44.53' S	85° 31.63' W
34	10/12	14:19	4467	19° 44.35' S	85° 31.98' W
35	10/13	14:19	4413	20° 00.02' S	84° 56.48' W
36 (b)	10/15	16:32	4452	20° 02.69' S	85° 13.30' W
37	10/15	16:51	4452	20° 02.60' S	85° 13.31' W
38 (b)	10/17	16:15	4467	20° 03.36' S	85° 13.08' W
39	10/17	16:34	4470	20° 03.36' S	85° 13.08' W
40 (b)	10/18	00:21	4450	20° 03.20' S	85° 13.06' W
41	10/18	00:34	4448	20° 03.19' S	85° 13.07' W
42	10/18	09:15	4347	20° 01.44' S	84° 00.92' W
43	10/18	12:12	4540	20° 00.63' S	83° 25.84' W
44	10/18	14:18	4417	20° 00.01' S	83° 00.93' W
45	10/18	16:51	4332	19° 59.98' S	82° 30.90' W
46	10/18	19:28	3970	20° 00.00' S	82° 00.85' W

Sample	Date (mm/dd)	Time (UTC)	Depth (m)	Lat.	Long.
47	10/18	22:21	3625	19° 59.98' S	81° 30.93' W
48	10/19	00:49	3289	19° 59.98' S	81° 00.88' W
49	10/19	06:39	3789	19° 59.99' S	80° 00.97' W
50	10/19	11:29	4116	20° 00.00' S	79° 00.37' W
51	10/19	13:48	4385	20° 00.00' S	78° 30.92' W
52	10/19	16:07	4455	19° 59.97' S	78° 00.74' W
53	10/19	18:23	4743	20° 00.01' S	77° 30.87' W
54	10/19	20:41	4528	19° 59.95' S	77° 00.92' W
55	10/19	22:59	4690	19° 59.98' S	76° 30.65' W
56	10/20	01:13	5022	20° 00.00' S	76° 00.81' W
57	10/20	05:51	5121	19° 59.97' S	75° 00.94' W
58	10/20	10:26	4964	19° 19.01' S	74° 30.00' W
59	10/20	14:52	4830	19° 03.62' S	74° 00.89' W
60	10/20	17:45	4357	18° 58.43' S	73° 30.86' W
61	10/20	20:38	4276	18° 53.68' S	73° 00.81' W
62	10/20	23:23	4931	18° 49.41' S	72° 30.64' W
63	10/21	02:19	5925	18° 44.70' S	72° 00.64' W

* (b) = bucket's samples

C. Teacher-at-Sea Program

Eric Heltzel is a teacher at Evanston High School in Evanston, Wyoming. This is the only high school in Uinta County School District #1 and has 850 students, in grades nine through twelve. Heltzel teaches ninth grade General Science, tenth grade Geography and Environmental Studies, and eleventh and twelfth grade Oceanography/Meteorology. Heltzel's participation in the cruise was sponsored by NOAA's Teacher at Sea (TAS) program in partnership with NOAA's Office of Climate Observation.

On board Heltzel worked closely with the Upper Ocean Processes Group from Woods Hole Oceanographic Institution. Senior Scientist Bob Weller gave him an active role by assigning a daily four hour watch in the main lab. Duties included monitoring the ship's location and deploying drifters and Argo Floats at the correct coordinates. Heltzel also participated in atmospheric studies by helping prepare and launch radiosondes attached to helium filled balloons. This presented an opportunity to watch the data streaming in and interpret the information. Heltzel also assisted with loading equipment in Miami and assisted with retrieval and deployment of Stratus buoys.

While on board Heltzel worked with and interviewed various members of the scientific teams and ship's officers and crew. Logs were sent out via email for publication on the TAS website. These described what was going on aboard the *Brown*, what goals the various studies have, and what life at sea is like. He also developed lessons related to the Stratus 6 cruise to be made available for other teachers and to be used in his classroom. Photographs were sent in support of the logs. Heltzel indicated that participating in this cruise was a tremendous learning experience that will enhance his teaching. He expressed gratitude to NOAA for being given the opportunity to participate in this Teacher at Sea experience.

ACKNOWLEDGEMENTS

This project was funded through grants from the Office of Global Programs of the National Oceanic and Atmospheric Administration (NOAA Grant NA17RJ1223). The UOP Group would like to thank the crew of the R/V *Ronald H. Brown* and all of the scientific staff for their help during the Stratus 2005 cruise.

APPENDIX A – CRUISE LOGISTICS

Hotel in Arica

Arica Hotel
Av. Commandante San Martin 599
Arica, Chile
56-58 254 540 fax 56-58 231 133
e-mail: resarica@panamericanahoteles.cl
more info at <http://www.panamericanahoteles.cl>
note country code for Chile is 56, so from U.S., dial 011 56 58 254 540

R/V Brown

More information about ship: <http://www.moc.noaa.gov/rb/>

Agent in Chile

A.J. Broom
main office in Valparaiso
POC Valparaiso: Jean Aguila <jmaguila@ajbroom.cl> or
operations@ajbroom.cl

Agent in Arica

Ivan Sanchez Ahumada <operationsari@ajbroom.cl>
Broom Arica
Phone: 56-58-250410
Cell: 0-97464445

APPENDIX B – MOORING LOGS

Moored Station Log

PAGE 1

(fill out log with black ball point pen only)

ARRAY NAME AND NO. Stratus 5 MOORED STATION NO. 1145

Launch (anchor over)

Date 14 December 2004 Time 18:25 UTC
day-mon-year
Latitude 19° 44.728' N or S Longitude 85° 31.159' E or W
deg-min deg-min
Position Source: GPS, LORAN, SAT. NAV., OTHER GPS
Deployed by: Lord, Weller Recorder/Observer: Keir Colbo
Ship and Cruise No Ron Brown 11-04 Intended duration: 365 days
Depth Recorder Reading 44.25 m Correction Source: Already
Depth Correction N/A m Applied
Corrected Water Depth N/A m Magnetic Variation: 7° 49' E or W
Anchor Position: Lat. 19° 44.741' N or S Long. 85° 31.360' E or W
Argos Platform ID No. see page 2 Additional Argos Info may be found
on pages 2 and 3.

Acoustic Release Information

Release No. 503121 Tested to 1500 meters
Receiver No. 3 Release Command 33
Interrogate Freq. 11 kHz Reply Freq. 10 kHz

Recovery (release fired)

Date 12 ~~Decemb~~ ^{October} 2005 Time 10:44:58 UTC
day-mon-year
Latitude 19° 44.50' N or S Longitude 85° 31.02' E or W
deg-min deg-min
Position Source: GPS, LORAN, SAT. NAV., OTHER GPS
Recovered by: Lord Recorder/Observer: Hutto
Ship and Cruise No. R/V Brown, RB-05-05 Actual duration: 301 days
Distance from actual waterline to buoy deck 0.6 meters

Surface Components

Buoy Type _____ Color(s) Hull yellow Tower white
white
 Buoy Markings If Found adrift contact Woods Hole Oceanographic Woods Hole, MA
02543 USA 508-548-1401

Surface Instrumentation			
Item	ID	Height *	Comments
Data Logger	L-04		System #1
Rel. Humidity	216	244	v3.2
Wind	221	270.5	v3.3 (Heise) v3.5/v1.5
Precip.	206	239	v3.5/v1.5 v3.4/v1.7
Longwave	218	282.5	v3.5/v1.6
Shortwave	219	282.5	v3.3/v1.6
Baro. Pressure	216	247	v3.3 (Heise)
ARGOS PTT	ID 27916		Wildcat # 12789
	ID 27917		
	ID 27918		
Data Logger	L-05		System #2
Rel. Humidity	232	246	v3.2
Wind	225	271	v3.5/v1.5
Precip.	205	239	v3.4/v1.7
Longwave	502	283	v3.5/v1.6
Shortwave	209	282.5	v3.3/v1.6
Baro. Pressure	217	247	v3.3 (Heise)
ARGOS PTT	ID 27919		Wildcat # 18171
	ID 27920		
	ID 27921		
BPR			ASIMET/stand alone not deployed
ARGOS SIS	ID 24576		S/N # 104

* Height above buoy deck in centimeters

Sub-Surface Instrumentation on Buoy and Bridle			
Item	ID	Depth†	Comments
SBE-37	1841	151	attached to system #1
SBE-37	1305	151	attached to system #2
SBE39	0718	0	Floating SST
			Estimated height of deck above waterline = 0.70m
† Depth below buoy deck in centimeters			

Sub-Surface Components

	Type	Size(s)	Manufacturer		
Chain					
Wire Rope					
Synthetics					
Hardware					
Flotation	Type (G.B.s, Spheres, etc)	Size	Quantity	Color	
No. of Flotation Clusters		90 balls			
Anchor Dry Weight		9300 lbs			

MOORED STATION NUMBER

1145

Depth
From
Diagram (m)

Item No.	Lgth [m]	Item	Inst No.	Time Over	Notes	Data No.	Calc Dpth	Time Back	Notes
	1	0.22	3/4" chain						
2	2		SBE-16	1873				17:43	
	3	0.37m	3/4" chain						
3.7	4		SBE-16	1875	11:36			17:53	
	5	1.95m	3/4" chain						
7	6		SBE-16	1880	11:33			17:56	
	7	1.25	3/4" chain						
10	8		VMCM	037	11:33	bands off 11:27		17:56	17:59 bands on
	9	0.83	3/4" chain						
13	10		Aanderaa	013	11:30			18:01	
	11	1.73	3/4" chain						
16	12		SBE-16	1881	11:30			18:02	fishing line
	13	2.25	3/4" chain						Bands on 1932
20	14		VMCM	032	11:28	bands off 11:24:30		18:04	fishing line not spinning
	15	2.78	3/4" chain						
25	16		T-POD	3258	11:25			18:06	
	17	3.66	3/4" chain						
30	18		SBE-16	2323	11:24			18:09	
	19	1.20	3/4" chain						
32.5	20		Aanderaa	78	11:22			18:10	

Date/Time (UTC)	Comments
14 December 04/11:06	start operations 19° 42.65' S 85° 37.57' W
14 December 04/11:50	Buoy in water
Oct. 13, 2005	Buoy on deck @ 17:44

Depth From Diagram (m)

MOORED STATION NUMBER

1145

Item No.	Lgth [m]	Item	Inst No.	Time Over	Notes	Data No.	Calc Dpth	Time Back	Notes
21	1.20	3/4" chain							
35 22		T-POD	3283	11:22				18:13	
23	1.05	3/4" chain							
37.5 24		xr 420	10514	11:20				18:14	
25	1.05	3/4" chain							
40 26		SBE37	1325	11:20				18:14	
27	3.15	3/4" chain							
45 28		VMCM	038	11:11	bands off and spin (11.14)			16:49	tangled fish line & hooks - stopped! 17.51 bands on
29	8.0	7/16" wire							
55 30		Anderaq	079	12:04				16:44	still fish line
31	6.2	7/16" wire							
62.5 32		SBE37	1326	12:08				16:40	still fishing line
33	6.2	7/16" wire							
70 34		T-POD	3704	12:12				16:36	fish hooks
35	6.2	7/16" wire							
77.5 36		T-POD	3762	12:24				16:32	
37	6.2	7/16" wire							
85 38		SBE37	1328	12:27				16:29	
39	6.2	7/16" wire							
92.6 40		T-POD	3830	12:31				16:26	
Date/Time		Comments							
14 Dec 04 / 17:19		Switched to hanging block on A-Frame							
12 Oct 05 / 16:53		Slipped top 40m and buoy free							

MOORED STATION NUMBER

1145

Depth
From
Diagram (m)

	Item No.	Lgth [m]	Item	Inst No.	Time Over	Notes	Data No.	Calc Dpth	Time Back	Notes
	41	2.32	3/4" chain							
96.3	42		SBE 37	1909	12:34				16:24	
	43	2.32	3/4" chain							
100	44		TPOD	3831	12:37				16:21	
	45	13.5	7/16" wire							
115	46		TPOD	3836	12:42				16:18	
	47	13.5	7/16" wire							
130	48		SBE 37	1329	12:45				16:14	trawl guard loose
	49	3.75	3/4" chain							
135	50		RDI	1218	12:50				16:10	
	51	8.0	7/16" wire							
145	52		VMCM	042	12:56	bands off 12:51			16:06	16:07 handson
	53	13.0	7/16" wire							
160	54		SBE 37	1330	12:59				16:03	
	55	13.5	7/16" wire							
175	56		T-POD	3837	13:02				15:58	
	57	6.2	7/16" wire							
183	58		Sontek	208	13:05				15:55	1st Goosehead
	59	6.2	7/16" wire							
190	60		SBE 37	1906	13:10				15:52	
		Date/Time		Comments						

MOORED STATION NUMBER 1145

Depth from Diagram (m)

Item No.	Lgth [m]	Item	Inst No.	Time Over	Notes	Data No.	Calc Dpth	Time Back	Notes
	28.5	7/16" wire							
2 20		SBE37	1908	13:15				15:48	
	13.0	7/16" wire							
2 35		VMCM	058	13:21	bands off 10:16:30 13:16:30			15:43	15:46 bands on
	13.0	7/16" wire							
2 50		SBE37	2012	13:27				15:39	
	38.0	3/8" wire							
2 90		VMCM	075	13:33	bands off 13:28:30			15:35	15:44 bands on
	18.0	3/8" wire							
3 10		SBE37	2015	13:38				15:31	
	38.0	3/8" wire							
3 50		VMCM	010	13:44	bands off 13:29:30			15:24	15:45 bands on
	500	3/8" wire						15:09*	
4 00		SBE39	0048	13:46	clamped on			15:22	
4 50		SBE39	0049	13:48	clamped on			15:20	
	500	3/8" wire		13:58				14:54	
	500	3/8" wire		14:17				14:37	
	100	3/8" wire		14:34] one piece wrapped			14:32	
	200	7/8" nylon		14:40				14:23	
	150	7/8" nylon		14:56				14:10	
Date/Time		Comments							
12 Oct 05		VMCM 010 1 blade on top rotor broken							

MOORED STATION NUMBER

1145

Item No.	Lgth [m]	Item	Inst No.	Time Over	Notes	Data No.	Calc Dpth	Time Back	Notes
81	1500	7/8" nylon		15:08				13:35	
82	100	1" nylon						13:32	
83	1500	1 1/2" poly		15:55	yale grip 5m From bottom			12:48	
84	90 ⁺²	glass balls		16:50	added 2 From diagram			12:34	
85	5	1/2" chain		17:28					
86		release	503121	18:05	pulled pin			12:38	
87	5	1/2" chain		18:13					
88	20	nystrom		18:15					
89	5	1/2" chain		18:22					
90		anchor		18:25					
91									
92									
93	5	chain			(added 5m of chain between poly and balls)				
94									
95									
96									
97									
98									
99									
100									

Date/Time	Comments
14 Dec 04/ 15:07	stop to transition from winch to H-bit
14 Dec 04/ 16:05	splice in poly
14 Dec 04/ 16:07	another splice in poly
14 Dec 04/ 16:20	" " "
14 Dec 04/ 16:35	poly on winch, off H-bit
14 Dec 04/ 17:30	towing for position

1111

Moored Station Log

PAGE 1

(fill out log with black ball point pen only)

ARRAY NAME AND NO. Stratus 6 MOORED STATION NO. 116#3

Launch (anchor over)

Date October 14, 2005 Time 17:51 UTC
day-mon-year
Latitude 20° 02.747' N or S Longitude 85° 11.471' E or W
deg-min deg-min
Position Source: GPS, LORAN, SAT. NAV., OTHER _____
Deployed by: Lord et.al. Recorder/Observer: Hutto
Ship and Cruise No R/V Ron Brown Intended duration: 365 days
Depth Recorder Reading 44796 m Correction Source: Matthew's Table
Depth Correction 5 m
Corrected Water Depth 4481 m Magnetic Variation: _____ E or W
Anchor Position: Lat. 20° 2.6703' N or S Long. 85° 11.3054' E or W
Argos Platform ID No. _____ Additional Argos Info may be found
on pages 2 and 3.

Acoustic Release Information

Release No. 30845 / 30848 Tested to 4400 meters
Receiver No. NA Release Command 151355 / 151262
Interrogate Freq. 11 kHz Reply Freq. 12 kHz

Recovery (release fired)

Date _____ Time _____ UTC
day-mon-year
Latitude _____ N or S Longitude _____ E or W
deg-min deg-min
Position Source: GPS, LORAN, SAT. NAV., OTHER _____
Recovered by: _____ Recorder/Observer: _____
Ship and Cruise No. _____ Actual duration: _____ days
Distance from actual waterline to buoy deck _____ meters

Surface Components

Buoy Type Foam Color(s) Hull yellow Tower white
 Buoy Markings If Found Contact Woods Hole Oceanographic Woods Hole MA 02543
USA 508-548-1401

Surface Instrumentation			
Item	ID	Height *	Comments
HRH	221	218	System #1
BPR	504	247	
WND	212	260	
PRC	207	249	
LWR	221	279	
SWR	505	279	
Logger	L-1		
PTT #14709	9805		
	9807		
	9811		
HRH	208	216	System #2
BPR	221	247	
WND	348	262	
PRC	505	249	
LWR	204	279	
SWR	207	279	
Logger	L-2		
PTT #14612	24337		
	27970		
	27971		
HRH	503	222	Stand Alone
LWR	506	279	Stand Alone
Floating SST	0716		
SiS Beacon	11427		SN# 22
* Height above buoy deck			

MOORED STATION NUMBER

1163

Item No.	Lgth [m]	Item	Inst No.	Time Over	Notes	Data No.	Calc Dpth	Time Back	Notes
1	0.22	3/4" chain							
2		SBE37	1899	12:24			2.0		
3	0.37	3/4" chain							
4		XR420	10515	12:24			3.7		
5	1.95	3/4" chain							
6		SBE37	2011	12:10			7.0		
7	1.25	3/4" chain							
8		VMCM	057	12:10	12:08 bands off		10		
9	2.85	3/4" chain							
10		Nortek	333	12:07			15		1 MHz ADCP Facing up
11		SBE37	1901	12:07			16		
12	2.25	3/4" chain							
13		VMCM	030	12:04	12:02 bands off		20		
14	2.78	3/4" chain							
15		TPOD	3764	12:02			25		
16	3.66	3/4" chain							
17		SBE37	1905	12:00			30		
18	0.52	3/4" chain							
19		Sontek	D197	12:00			32.5		ADCP facing down
20	1.59	3/4" chain							
Date/Time		Comments							
Oct. 14, 2005		12:24 Buoy in water							

MOORED STATION NUMBER

1163

Item No.	Lgth [m]	Item	Inst No.	Time Over	Notes	Data No.	Calc Dpth	Time Back	Notes
21		TPOD	3839	11:57			35	9"	
22	3.66	3/4" chain							
23		SBE37	1912	11:55			40		
24	3.30	3/4" chain							
25		VMCM	029	11:53	11:45 bands off		45		
26	15.25	7/16" wire							
27		SBE 37	1902	12:47			62.5		
28	6.2	7/16" wire							
29		TPOD	4481	12:50			70		
30	6.2	7/16" wire							
31		TPOD	4488	12:53			77.5		
32	6.2	7/16" wire							
33		SBE37	1910	12:55			85		
34	6.2	7/16" wire							
35		TPOD	4489	12:56			92.5		
36	5.7	7/16" wire							
37		VMCM	053	13:00	12:56 bands off		100		
38	12.8	7/16" wire							
39		TPOD	4494	13:04			115		
40	13.5	7/16" wire							
Date/Time		Comments							

MOORED STATION NUMBER 11643

Item No.	Lgth [m]	Item	Inst No.	Time Over	Notes	Data No.	Calc Dpth	Time Back	Notes
41	3.66	SBE37	1903	13:06			130		
42	3.66	3/4" cham							
43		RDI	1220	13:09			135		
44	8	7/16" wire							
45		VMCM	076	13:12	13:09 bands off		145		
46	12.8	7/16" wire							
47		SBE16	0927	13:15			160		
48	13.5	7/16" wire							
49		TPOD	4495	13:17			175		
50	6.2	7/16" wire							
51		Sontek	D193	13:19			183		ADCM facing down
52	6.2	7/16" wire							
53		SBE16	1877	13:23			190		
54	28.5	7/16" wire							
55		SBE16	0928	13:26			220		
56	13	7/16" wire							
57		VMCM	008	13:29	13:26 bands off		235		
58	13	7/16" wire							
59		SBE16	0994	13:31			250		
60	38	3/8" wire							
Date/Time			Comments						

MOORED STATION NUMBER

11643

Item No.	Lgth [m]	Item	Inst No.	Time Over	Notes	Data No.	Calc Dpth	Time Back	Notes
61		VMCM	034	13:34	13:31 bands off		290		
62	18	3/8" wire							
63		SBE16	0993	13:37			310		
64	38	3/8" wire							
65		VMCM	040	13:39	13:37 bands off		350		
66	500	3/8" wire							
67		SBE39	0282	13:42			400		clamped on
68		SBE39	0203	13:43			450		clamped on
69	500	3/8" wire		13:55					
70	500	3/8" wire		14:17					
71	100	3/8" wire		14:47					} one piece wrapped termination
72	200	7/8" nylon		14:52					
73	150	7/8" nylon		15:00					} one piece spliced
74	1500	7/8" nylon		15:11					
75	100	1" nylon		15:47					
76	1500	1 1/8" poly		15:50					
77		17" Glass Balls		17:12	All balls in				90 total on 1/2" chain
78	5	1/2" chain		17:19					
79		Acoustic Release		17:20					EGG Model 8242
80									

m →
2" chain

Date/Time	Comments
Oct. 14, 2005	4123-5 and 4069-74 wire shots have cracks (500m) (100m)

THH NH HH TH III

MOORED STATION NUMBER 116#3

Item No.	Lgth [m]	Item	Inst No.	Time Over	Notes	Data No.	Calc Dpth	Time Back	Notes
81	5	1/2" chain		17:26					
82	20	1" Samson Nylon		17:36					
83	5	1/2" chain		17:51					
84		Anchor		17:51					Wet Wt. 8000 lbs.
85									
86									
87									
88									
89									
90									
91									
92									
93									
94									
95									
96									
97									
98									
99									
100									
Date/Time		Comments							

APPENDIX C – BUOY SPINS

Stratus 5 Primary Buoy Spin Woods Hole

309 deg. Heading

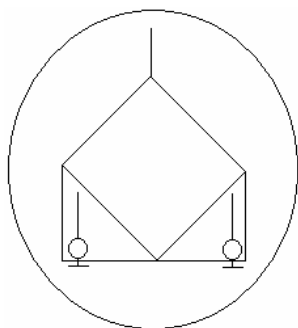

Vanes Secured Time/Date UTC: 17:23:30, 11 JUN 04

System 1	Compass	Vane	Direction	Time UTC
Logger #: L04				
Stop Sampling: 17:36:15				
Wind #: WND221	131.5	179.0	310.5	17:37:00
Restart Sampling: 17:37:15				

System 2	Compass	Vane	Direction	Time UTC
Logger #: L05				
Stop Sampling: 17:38:30				
Wind #: WND225	136.3	178.8	315.1	17:39:00
Restart Sampling: 17:39:15				

309 deg. Heading

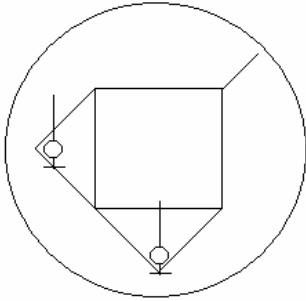

Vanes Secured Time/Date UTC: 17:43:30, 11 JUN 04

System 1	Compass	Vane	Direction	Time UTC
Logger #: L04				
Stop Sampling: 17:54:30				
Wind #: WND221	171.9	137.1	308.0	17:55:00
Restart Sampling: 17:55:30				

System 2	Compass	Vane	Direction	Time UTC
Logger #: L05				
Stop Sampling: 17:56:30				
Wind #: WND225	173.8	137.0	310.8	17:57:00
Restart Sampling: 17:57:30				

309 deg. Heading

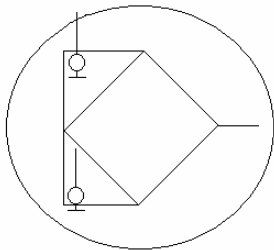

Vanes Secured Time/Date UTC: 18:01:00, 11 JUN 04

System 1	Compass	Vane	Direction	Time UTC
Logger #: L04				
Stop Sampling: 18:18:15				
Wind #: WND221	219.8	89.8	309.6	18:18:45
Restart Sampling: 18:19:00				

System 2	Compass	Vane	Direction	Time UTC
Logger #: L05				
Stop Sampling: 18:19:30				
Wind #: WND225	217.5	89.8	307.3	18:20:00
Restart Sampling: 18:20:30				

309 deg. Heading

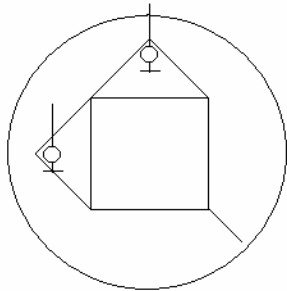

Vanes Secured Time/Date UTC: 18:24:00, 11 JUN 04

System 1	Compass	Vane	Direction	Time UTC
Logger #: L04				
Stop Sampling: 18:35:30				
Wind #: WND221	264.6	45.2	309.8	18:36:00
Restart Sampling: 18:36:30				

System 2	Compass	Vane	Direction	Time UTC
Logger #: L05				
Stop Sampling: 18:36:45				
Wind #: WND225	261.5	46.8	308.3	18:37:15
Restart Sampling: 18:37:45				

309 deg. Heading

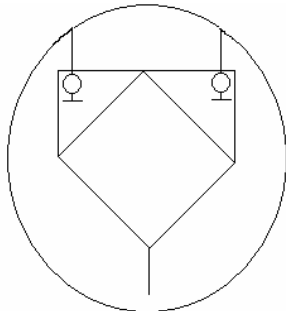

Vanes Secured Time/Date UTC: 18:41:00, 11 JUN 04

System 1	Compass	Vane	Direction	Time UTC
Logger #: L04				
Stop Sampling: 18:52:30				
Wind #: WND221	313.0	356.3	309.3	18:53:00
Restart Sampling: 18:53:30				

System 2	Compass	Vane	Direction	Time UTC
Logger #: L05				
Stop Sampling: 18:53:45				
Wind #: WND225	312.9	359.1	312.0	18:54:30
Restart Sampling: 18:54:45				

309 deg. Heading

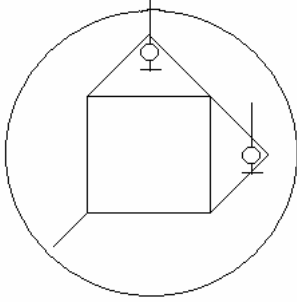

Vanes Secured Time/Date UTC: 18:58:00, 11 JUN 04

System 1	Compass	Vane	Direction	Time UTC
Logger #: L04				
Stop Sampling: 19:09:30				
Wind #:	WND221	354.4	315.0	309.4
Restart Sampling: 19:10:30				

System 2	Compass	Vane	Direction	Time UTC
Logger #: L05				
Stop Sampling: 19:11:00				
Wind #:	WND225	354.0	317.8	311.8
Restart Sampling: 19:12:00				

309 deg. Heading

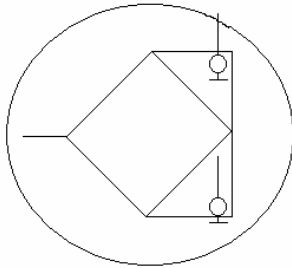

Vanes Secured Time/Date UTC: 19:15:00, 11 JUN 04

System 1	Compass	Vane	Direction	Time UTC
Logger #: L04				
Stop Sampling: 19:32:15				
Wind #:	WND221	43.4	266.3	309.7
Restart Sampling: 19:33:30				

System 2	Compass	Vane	Direction	Time UTC
Logger #: L05				
Stop Sampling: 19:33:45				
Wind #:	WND225	43.6	267.3	310.9
Restart Sampling: 19:34:30				

309 deg. Heading

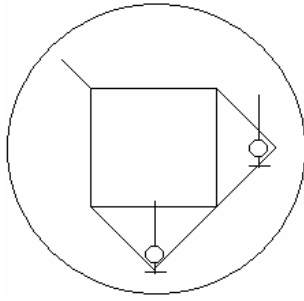

Vanes Secured Time/Date UTC: 19:38:00, 11 JUN 04

System 1	Compass	Vane	Direction	Time UTC
Logger #: L04				
Stop Sampling: 19:49:30				
Wind #:	WND221	88.0	221.3	309.3
Restart Sampling: 19:50:30				

System 2	Compass	Vane	Direction	Time UTC
Logger #: L05				
Stop Sampling: 19:50:45				
Wind #:	WND225	92.3	222.2	314.5
Restart Sampling: 19:51:45				

Stratus 5 Primary Buoy Spin, Arica, Chile

123 deg. Heading

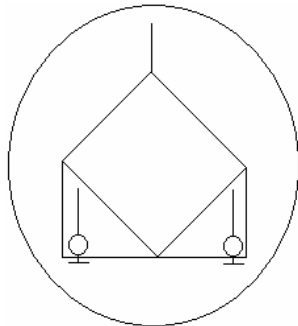

Vanes Secured Time/Date UTC: 11:52:00, 2 DEC 04

System 1	Compass	Vane	Direction	Time UTC
Logger #: L04				
Stop Sampling: 12:19:30				
Wind #:	WND221	306.4	178.9	125.3
Restart Sampling: 12:20:30				

System 2	Compass	Vane	Direction	Time UTC
Logger #: L05				
Stop Sampling: 12:20:30				
Wind #:	WND225	306.1	179.0	125.1
Restart Sampling: 12:21:30				

123 deg. Heading

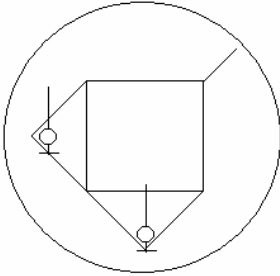

Vanes Secured Time/Date UTC: 12:26:00, 2 DEC 04

System 1	Compass	Vane	Direction	Time UTC
Logger #: L04				
Stop Sampling: 12:44:30				
Wind #: WND221	347.6	137.3	124.9	12:45:00
Restart Sampling: 12:45:30				

System 2	Compass	Vane	Direction	Time UTC
Logger #: L05				
Stop Sampling: 12:45:30				
Wind #: WND225	346.8	136.5	123.3	12:46:00
Restart Sampling: 12:46:30				

123 deg. Heading

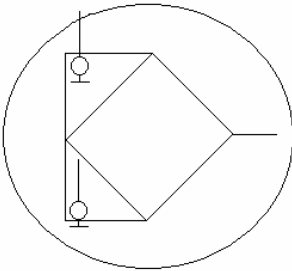

Vanes Secured Time/Date UTC: 12:51:00, 2 DEC 04

System 1	Compass	Vane	Direction	Time UTC
Logger #: L04				
Stop Sampling: 13:06:30				
Wind #: WND221	36.8	87.2	124.0	13:07:00
Restart Sampling: 13:07:30				

System 2	Compass	Vane	Direction	Time UTC
Logger #: L05				
Stop Sampling: 13:07:30				
Wind #: WND225	35.3	86.3	121.6	13:08:00
Restart Sampling: 13:08:30				

123 deg. Heading

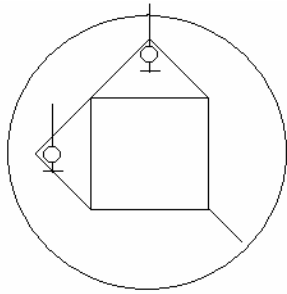

Vanes Secured Time/Date UTC: 13:12:00, 2 DEC 04

System 1	Compass	Vane	Direction	Time UTC
Logger #: L04				
Stop Sampling: 13:28:30				
Wind #: WND221	80.6	40.7	121.3	13:29:00
Restart Sampling: 13:29:30				

System 2	Compass	Vane	Direction	Time UTC
Logger #: L05				
Stop Sampling: 13:29:30				
Wind #: WND225	80.6	42.4	123.0	13:30:00
Restart Sampling: 13:30:30				

123 deg. Heading

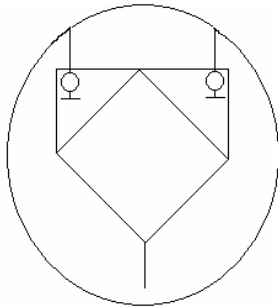

Vanes Secured Time/Date UTC: 13:34:00, 2 DEC 04

System 1	Compass	Vane	Direction	Time UTC
Logger #: L04				
Stop Sampling: 13:49:30				
Wind #: WND221	123.1	358.2	121.3	13:50:00
Restart Sampling: 13:50:30				

System 2	Compass	Vane	Direction	Time UTC
Logger #: L05				
Stop Sampling: 13:50:30				
Wind #: WND225	124.9	358.7	124.6	13:51:00
Restart Sampling: 13:51:30				

123 deg. Heading

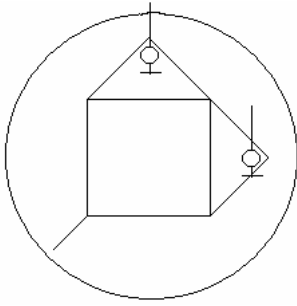

Vanes Secured Time/Date UTC: 13:54:00, 2 DEC 04

System 1	Compass	Vane	Direction	Time UTC
Logger #: L04				
Stop Sampling: 14:10:30				
Wind #: WND221	164.5	317.5	122.0	14:11:00
Restart Sampling: 14:11:30				

System 2	Compass	Vane	Direction	Time UTC
Logger #: L05				
Stop Sampling: 14:11:30				
Wind #: WND225	165.2	318.9	124.1	14:12:00
Restart Sampling: 14:12:30				

123 deg. Heading

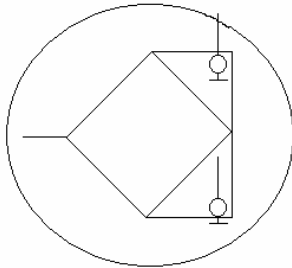

Vanes Secured Time/Date UTC: 14:16:00, 2 DEC 04

System 1	Compass	Vane	Direction	Time UTC
Logger #: L04				
Stop Sampling: 14:32:30				
Wind #: WND221	214.1	268.5	122.6	14:33:00
Restart Sampling: 14:33:30				

System 2	Compass	Vane	Direction	Time UTC
Logger #: L05				
Stop Sampling: 14:33:30				
Wind #: WND225	211.9	269.7	121.6	14:34:00
Restart Sampling: 14:34:30				

123 deg. Heading

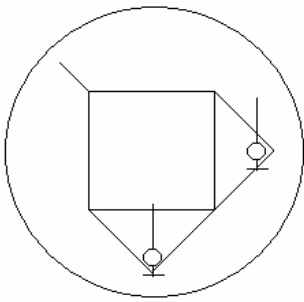

Vanes Secured Time/Date UTC: 14:38:00, 2 DEC 04

System	Compass	Vane	Direction	Time UTC
System 1				
Logger #:	L04			
Stop Sampling:	14:56:30			
Wind #:	WND221	264.7	220.1	124.8
Restart Sampling:	14:57:30			

System	Compass	Vane	Direction	Time UTC
System 2				
Logger #:	L05			
Stop Sampling:	14:57:30			
Wind #:	WND225	263.0	220.2	123.2
Restart Sampling:	14:58:30			

Note: Vanes unblocked @ 14:59:30
 Solars uncovered @ 15:01:00

Stratus 6 Primary Buoy Spin #1, Woods Hole

309 deg. Heading

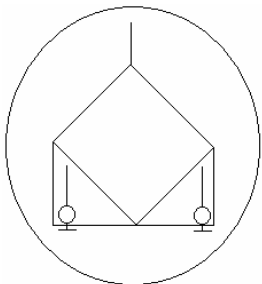

Vanes Secured Time/Date UTC: 11:49:00, 17 AUG 05

System	Compass	Vane	Direction	Time UTC
System 1				
Logger #:	L-01			
Stop Sampling:	12:05:30			
Wind #:	212	121.8	185.9	307.7
Restart Sampling:	12:06:30			

System	Compass	Vane	Direction	Time UTC
System 2				
Logger #:	L-02			
Stop Sampling:	12:07:30			
Wind #:	206	129.2	179.2	308.4
Restart Sampling:	12:08:30			

309 deg. Heading

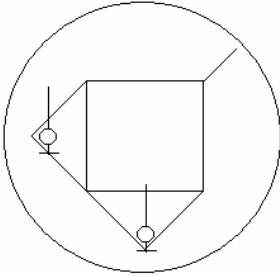

Vanes Secured Time/Date UTC: 12:15:00, 17 AUG 05

System 1	Compass	Vane	Direction	Time UTC
Logger #: L-01				
Stop Sampling: 12:31:30				
Wind #: 212	167.9	140.9	308.8	12:32:30
Restart Sampling: 12:40:00				

System 2	Compass	Vane	Direction	Time UTC
Logger #: L-02				
Stop Sampling: 12:37:00				
Wind #: 206	174.5	132.8	307.3	12:38:00
Restart Sampling: 12:39:00				

309 deg. Heading

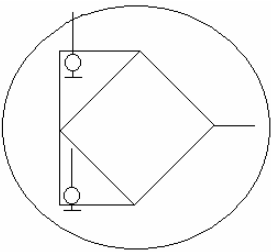

Vanes Secured Time/Date UTC: 12:45:00, 17 AUG 05

System 1	Compass	Vane	Direction	Time UTC
Logger #: L-01				
Stop Sampling: 13:00:30				
Wind #: 212	216.8	93.3	310.1	13:01:00
Restart Sampling: 13:02:15				

System 2	Compass	Vane	Direction	Time UTC
Logger #: L-02				
Stop Sampling: 13:03:30				
Wind #: 206	216.8	87.4	304.2	13:04:30
Restart Sampling: 13:05:00				

309 deg. Heading

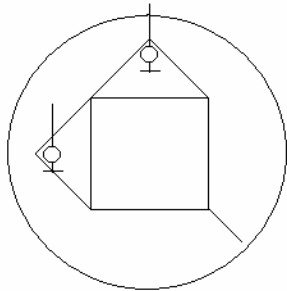

Vanes Secured Time/Date UTC: 13:11:00, 17 AUG 05

System 1	Compass	Vane	Direction	Time UTC
Logger #: L-01				
Stop Sampling: 13:31:30				
Wind #: 212	258.8	48.0	306.8	13:32:00
Restart Sampling: 13:32:30				

System 2	Compass	Vane	Direction	Time UTC
Logger #: L-02				
Stop Sampling: 13:33:30				
Wind #: 206	259.2	43.4	302.6	13:34:00
Restart Sampling: 13:34:30				

309 deg. Heading

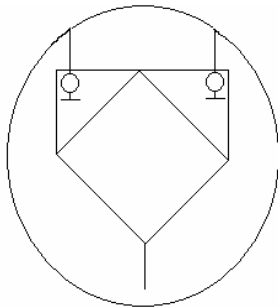

Vanes Secured Time/Date UTC: 13:39:00, 17 AUG 05

System 1	Compass	Vane	Direction	Time UTC
Logger #: L-01				
Stop Sampling: 13:59:30				
Wind #: 212	302.9	359.6	302.5	14:00:00
Restart Sampling: 14:00:30				

System 2	Compass	Vane	Direction	Time UTC
Logger #: L-02				
Stop Sampling: 14:01:30				
Wind #: 206	306.2	357.2	303.4	14:02:00
Restart Sampling: 14:02:30				

309 deg. Heading

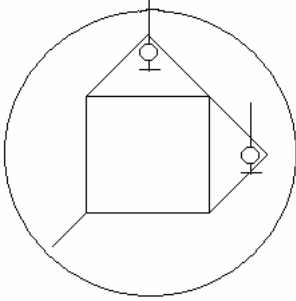

Vanes Secured Time/Date UTC: 14:10:00, 17 AUG 05

System 1	Compass	Vane	Direction	Time UTC
Logger #: L-01				
Stop Sampling: 14:26:30				
Wind #: 212	347.9	318.6	306.5	14:27:00
Restart Sampling: 14:27:30				

System 2	Compass	Vane	Direction	Time UTC
Logger #: L-02				
Stop Sampling: 14:28:30				
Wind #: 206	351.0	314.7	305.7	14:29:00
Restart Sampling: 14:29:30				

309 deg. Heading

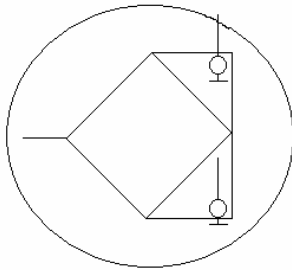

Vanes Secured Time/Date UTC: 14:36:00, 17 AUG 05

System 1	Compass	Vane	Direction	Time UTC
Logger #: L-01				
Stop Sampling: 14:55:30				
Wind #: 212	35.5	274.5	310.0	14:56:00
Restart Sampling: 14:56:30				

System 2	Compass	Vane	Direction	Time UTC
Logger #: L-02				
Stop Sampling: 14:57:30				
Wind #: 206	36.2	270.5	306.7	14:58:00
Restart Sampling: 14:58:30				

309 deg. Heading

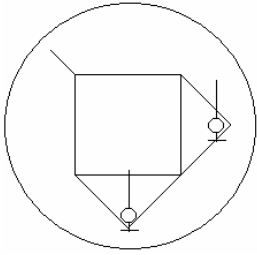

Vanes Secured Time/Date UTC: 15:02:00, 17 AUG 05

System 1	Compass	Vane	Direction	Time UTC
Logger #: L-01				
Stop Sampling: 15:22:30				
Wind #: 212	82.7	229.8	312.5	15:23:30
Restart Sampling: 15:25:30				

System 2	Compass	Vane	Direction	Time UTC
Logger #: L-02				
Stop Sampling: 15:27:00				
Wind #: 206	85.7	222.0	307.7	15:27:30
Restart Sampling: 15:28:30				

Stratus 6 Primary Buoy Spin #2, Woods Hole

309 deg. Heading

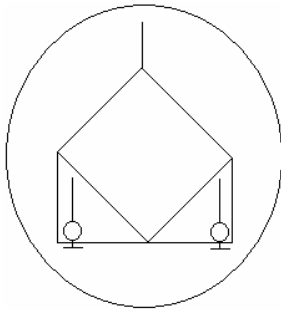

Vanes Secured Time/Date UTC: 16:11:00 17AUG05

System 1	Compass	Vane	Direction	Time UTC
Logger #: L-01				
Stop Sampling: 16:29:30				
Wind #: 212	183.9	309.4	309.4	16:30:00
Restart Sampling: 16:30:30				

System 2	Compass	Vane	Direction	Time UTC
Logger #: L-02				
Stop Sampling: 16:41:30				
Wind #: 348	139.6	169.2	309.2	16:42:00
Restart Sampling: 16:42:30				

309 deg. Heading

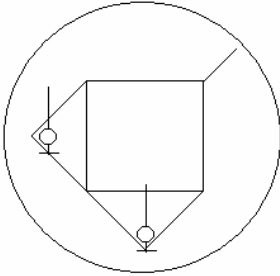

Vanes Secured Time/Date UTC: 16:46:00 17AUG05

System 1	Compass	Vane	Direction	Time UTC
Logger #: L-01				
Stop Sampling: 17:09:30				
Wind #:	167.5	143.1	310.6	17:10:00
Restart Sampling: 17:12:00				

System 2	Compass	Vane	Direction	Time UTC
Logger #: L-02				
Stop Sampling: 17:13:00				
Wind #:	179	128.9	307.9	17:13:30
Restart Sampling: 17:15:00				

309 deg. Heading

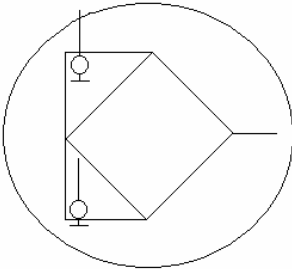

Vanes Secured Time/Date UTC: 17:27:00 17AUG05

System 1	Compass	Vane	Direction	Time UTC
Logger #: L-01				
Stop Sampling: 17:45:30				
Wind #:	216.8	93.9	310.7	17:46:00
Restart Sampling: 17:46:30				

System 2	Compass	Vane	Direction	Time UTC
Logger #: L-02				
Stop Sampling: 17:47:30				
Wind #:	224.1	81.5	305.6	17:48:00
Restart Sampling: 17:48:30				

309 deg. Heading

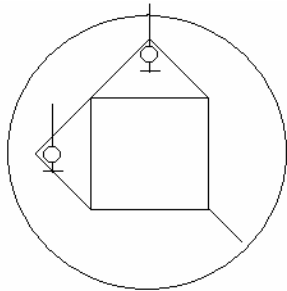

Vanes Secured Time/Date UTC: 17:52:00 17AUG05

System 1	Compass	Vane	Direction	Time UTC
----------	---------	------	-----------	----------

Logger #: L-01

Stop Sampling: 18:09:30

Wind #:	262.8	45.5	308.3	18:10:00
---------	-------	------	-------	----------

Restart Sampling: 18:10:30

System 2	Compass	Vane	Direction	Time UTC
----------	---------	------	-----------	----------

Logger #: L-02

Stop Sampling: 18:11:30

Wind #:	274.1	32.6	306.7	18:12:00
---------	-------	------	-------	----------

Restart Sampling: 18:13:00

309 deg. Heading

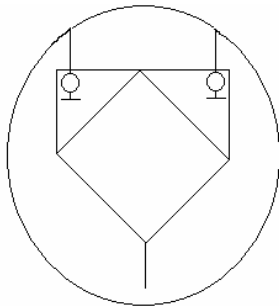

Vanes Secured Time/Date UTC: 18:17:30 17AUG05

System 1	Compass	Vane	Direction	Time UTC
----------	---------	------	-----------	----------

Logger #: L-01

Stop Sampling: 18:34:30

Wind #:	299.7	4.4	304.1	18:35
---------	-------	-----	-------	-------

Restart Sampling: 18:36:30

System 2	Compass	Vane	Direction	Time UTC
----------	---------	------	-----------	----------

Logger #: L-02

Stop Sampling: 18:37:30

Wind #:	318.5	348.6	307.1	18:39
---------	-------	-------	-------	-------

Restart Sampling: 19:11:00

309 deg. Heading

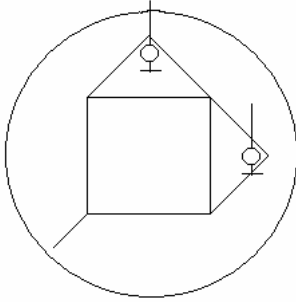

Vanes Secured Time/Date UTC: 19:14:00 17AUG05

System 1	Compass	Vane	Direction	Time UTC
Logger #: L-01				
Stop Sampling: 19:31:30				
Wind #:	347.0	317.9	304.9	19:32
Restart Sampling: 19:32:30				

System 2	Compass	Vane	Direction	Time UTC
Logger #: L-02				
Stop Sampling: 19:33:30				
Wind #:	2.6	303.6	306.2	19:34
Restart Sampling: 19:34:30				

309 deg. Heading

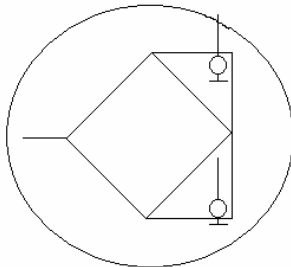

Vanes Secured Time/Date UTC: 19:40:00 17AUG05

System 1	Compass	Vane	Direction	Time UTC
Logger #: L-01				
Stop Sampling: 19:58:00				
Wind #:	36.5	273.9	310.4	19:59:30
Restart Sampling: 20:00:00				

System 2	Compass	Vane	Direction	Time UTC
Logger #: L-02				
Stop Sampling: 20:02:15				
Wind #:	46.2	258.9	305.1	20:02:30
Restart Sampling: 20:03:30				

309 deg. Heading

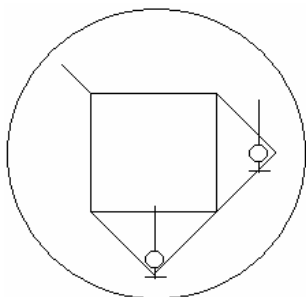

Vanes Secured Time/Date UTC: 20:08:00 17AUG05

System 1	Compass	Vane	Direction	Time UTC
Logger #: L-01				
Stop Sampling: 20:27:00				
Wind #:	81.7	230	311.7	20:27:30
Restart Sampling: 20:28:30				

System 2	Compass	Vane	Direction	Time UTC
Logger #: L-02				
Stop Sampling: 20:30:00				
Wind #:	93.1	214.7	307.8	20:30:30
Restart Sampling: 20:31:00				

Stratus 6 Primary Buoy Spin #3, Woods Hole

309 deg. Heading

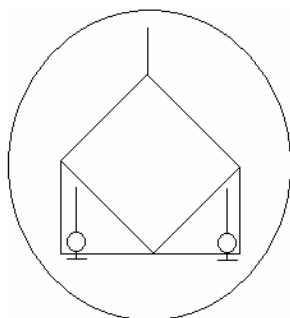

Vanes Secured Time/Date UTC: 10:11:00, 20 AUG 05

System 1	Compass	Vane	Direction	Time UTC
Logger #: L-01				
Stop Sampling: 10:26:30				
Wind #: 212	126.2	184.3	310.5	10:28:00
Restart Sampling: 10:32:30				

System 2	Compass	Vane	Direction	Time UTC
Logger #: L-02				
Stop Sampling: 10:27:30				
Wind #: 348	139.1	168.5	307.6	10:30:00
Restart Sampling: 10:31:30				

309 deg. Heading

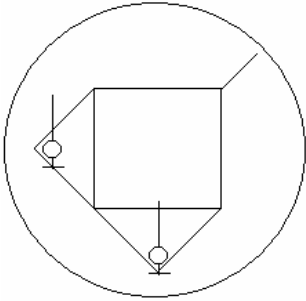

Vanes Secured Time/Date UTC: 10:33:00, 20 AUG 05

System 1	Compass	Vane	Direction	Time UTC
Logger #: L-01				
Stop Sampling: 10:51:30				
Wind #: 212	167.9	142.2	310.1	10:54:00
Restart Sampling: 10:57:30				

System 2	Compass	Vane	Direction	Time UTC
Logger #: L-02				
Stop Sampling: 10:52:30				
Wind #: 348	180.5	128.5	309.0	10:55:00
Restart Sampling: 10:55:30				

309 deg. Heading

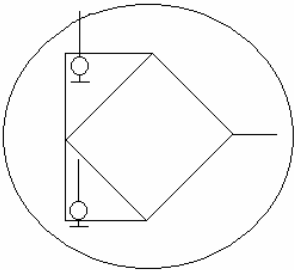

Vanes Secured Time/Date UTC: 10:58:00, 20 AUG 05

System 1	Compass	Vane	Direction	Time UTC
Logger #: L-01				
Stop Sampling: 11:14:30				
Wind #: 212	219.1	91.3	310.4	11:16:00
Restart Sampling: 11:19:30				

System 2	Compass	Vane	Direction	Time UTC
Logger #: L-02				
Stop Sampling: 11:15:30				
Wind #: 348	229.2	79.1	308.3	11:17:00
Restart Sampling: 11:18:30				

309 deg. Heading

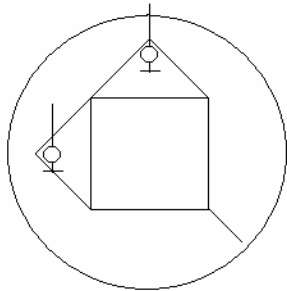

Vanes Secured Time/Date UTC: 11:20:00, 20 AUG 05

System 1	Compass	Vane	Direction	Time UTC
Logger #: L-01				
Stop Sampling: 11:38:30				
Wind #: 212	261.8	48.0	309.8	11:40:00
Restart Sampling: 11:43:30				

System 2	Compass	Vane	Direction	Time UTC
Logger #: L-02				
Stop Sampling: 11:39:30				
Wind #: 348	274.5	33.7	308.2	11:41:00
Restart Sampling: 11:42:30				

309 deg. Heading

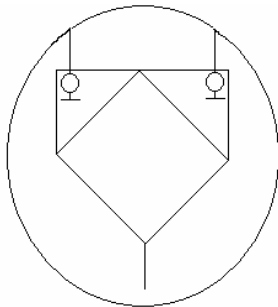

Vanes Secured Time/Date UTC: 11:44:00, 20 AUG 05

System 1	Compass	Vane	Direction	Time UTC
Logger #: L-01				
Stop Sampling: 12:01:30				
Wind #: 212	302.7	5.1	307.8	12:03:00
Restart Sampling: 12:06:30				

System 2	Compass	Vane	Direction	Time UTC
Logger #: L-02				
Stop Sampling: 12:02:30				
Wind #: 348	319.8	348.3	308.1	12:04:00
Restart Sampling: 12:05:30				

309 deg. Heading

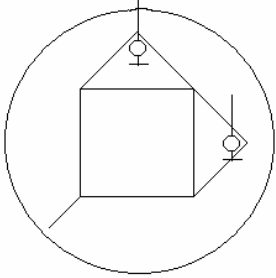

Vanes Secured Time/Date UTC: 12:08:00, 20 AUG 05

System 1	Compass	Vane	Direction	Time UTC
Logger #: L-01				
Stop Sampling: 12:28:30				
Wind #: 212	345.7	321.6	307.3	12:31:00
Restart Sampling: 12:35:30				

System 2	Compass	Vane	Direction	Time UTC
Logger #: L-02				
Stop Sampling: 12:29:30				
Wind #: 348	3.5	304.2	307.7	12:32:00
Restart Sampling: 12:33:30				

309 deg. Heading

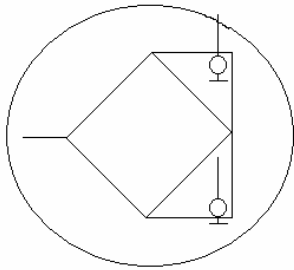

Vanes Secured Time/Date UTC: 12:38:00, 20 AUG 05

System 1	Compass	Vane	Direction	Time UTC
Logger #: L-01				
Stop Sampling: 12:55:30				
Wind #: 212	39.8	272.9	312.7	12:57:00
Restart Sampling: 13:01:30				

System 2	Compass	Vane	Direction	Time UTC
Logger #: L-02				
Stop Sampling: 12:56:30				
Wind #: 348	51.3	257.5	308.8	12:58:00
Restart Sampling: 12:59:30				

309 deg. Heading

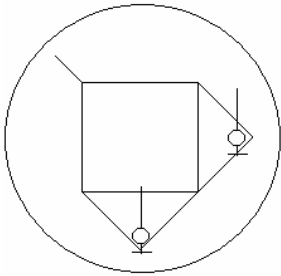

Vanes Secured Time/Date UTC: 13:03:00, 20 AUG 05

System 1	Compass	Vane	Direction	Time UTC
Logger #: L-01				
Stop Sampling: 13:27:30				
Wind #: 212	83.2	225.6	308.8	13:28:00
Restart Sampling: 13:28:30				

System 2	Compass	Vane	Direction	Time UTC
Logger #: L-02				
Stop Sampling: 13:29:30				
Wind #: 348	94.7	214.6	309.3	13:30:00
Restart Sampling: 13:30:30				

APPENDIX D – INSTRUMENT NOTES

Stratus 5 NGVM Pre-cruise Set-up

NGVM-075

Set clock to UTC: Done

Erase FLASH memory: Done

Start sampling @: 12:43:30, 7 DEC 04 UTC

1st sample taken @: 12:45:00, 7 DEC 04 UTC

Sample interval: 1 min.

1st Rotor spins @ 15:11:30, 9 DEC 04

2nd Rotor spins @ 19:28:30, 9 DEC 04

Unblock rotors @ 13:28:30, 14 DEC 04

NGVM-032

Set clock to UTC: Done

Erase FLASH memory: Done

Start sampling @: 15:58:30, 7 DEC 04 UTC

1st sample taken @: 16:00:00, 7 DEC 04 UTC

Sample interval: 1 min.

1st Rotor spins @ 15:09:30, 9 DEC 04

2nd Rotor spins @ 19:27:30, 9 DEC 04

Unblock rotors @ 11:24:30, 14 DEC 04

NGVM-058

Set clock to UTC: Done

Erase FLASH memory: Done

Start sampling @: 16:04:30, 7 DEC 04 UTC

1st sample taken @: 16:06:00, 7 DEC 04 UTC

Sample interval: 1 min.

1st Rotor spins @ 15:13:30 (Lower) 15:14:30 (Upper), 9 DEC 04

2nd Rotor spins @ 19:30:30, 9 DEC 04

Unblock rotors @ 13:16:30, 14 DEC 04

NGVM-042

Set clock to UTC: Done

Erase FLASH memory: Done

Start sampling @: 16:18:30, 7 DEC 04 UTC

1st sample taken @: 16:20:00, 7 DEC 04 UTC

Sample interval: 1 min.

1st Rotor spins @ 15:08:30, 9 DEC 04

2nd Rotor spins @ 19:26:30, 9 DEC 04

Unblock rotors @ 12:51:00, 14 DEC 04

NGVM-010

Set clock to UTC: Done
Erase FLASH memory: Done
Start sampling @: 16:26:30, 7 DEC 04 UTC
1st sample taken @: 16:28:00, 7 DEC 04 UTC
Sample interval: 1 min.
1st Rotor spins @ 15:16:30, 9 DEC 04
2nd Rotor spins @ 19:32:30, 9 DEC 04
Unblock rotors @ 13:29:30, 14 DEC 04

NGVM-038

Set clock to UTC: Done
Erase FLASH memory: Done
Start sampling @: 16:48:30, 7 DEC 04 UTC
1st sample taken @: 16:50:00, 7 DEC 04 UTC
Sample interval: 1 min.
1st Rotor spins @ 15:10:30, 9 DEC 04
2nd Rotor spins @ 19:29:30, 9 DEC 04
Unblock rotors @ 11:14:00, 14 DEC 04

NGVM-037

Set clock to UTC: Done
Erase FLASH memory: Done
Start sampling @: 17:28:30, 7 DEC 04 UTC
1st sample taken @: 17:30:00, 7 DEC 04 UTC
Sample interval: 1 min.
1st Rotor spins @ 15:17:30, 9 DEC 04
2nd Rotor spins @ 19:31:30, 9 DEC 04
Unblock rotors @ 11:27:00, 14 DEC 04

Stratus 5 Post Cruise

Primary 1 Logger clock check (#STAT) Note Time/Date UTC: 13:13:02, 13 OCT 05
Primary 1 Logger clock check Note Time/Date from Logger (L-04): 13:13:50, 13 OCT 05

Primary 2 Logger clock check (#STAT) Note Time/Date UTC: 13:16:12, 13 OCT 05
Primary 2 Logger clock check Note Time/Date from Logger (L-05): 13:17:07, 13 OCT 05

Primary 1 Logger Stop Sampling Note Time/Date UTC: 17:41:37, 13 OCT 05
Logger 1 Records Used: 454915
Primary 2 Logger Stop Sampling Note Time/Date UTC: 17:47:08, 13 OCT 05
Logger 2 Records Used: 454924

Stratus 5 Instrument Clock Checks

Instrument	Serial Number	Inst. Clock	UTC	Date	Stop Time	Records
SBE-39	0048	09:25:12	09:25:30	13 OCT 05	09:26:00	90533
	0049	09:27:07	09:28:00	13 OCT 05	09:28:30	90534
	0718	No Comms	Battery=7.6			
SBE-1621	1875	20:50:28	20:45:30	13 OCT 05	20:46:00	90094
	1881	20:56:17	20:51:00	13 OCT 05	20:51:30	90095
	2323	20:52:44	20:48:15	13 OCT 05	20:48:15	90094
	1873	08:48:20	08:48:00	14 OCT 05	08:48:30	90238
	1880	08:49:40	08:49:30	14 OCT 05	08:50:30	90238
SBE-37	2012	08:53:26	08:52:30	14 OCT 05	08:53:30	90815
	1328	14:11:20	14:10:30	14 OCT 05	14:11:00	90878
	1329	14:13:52	14:13:00	14 OCT 05	14:13:30	90879
	1906	14:15:24	14:14:30	14 OCT 05	14:15:00	90879
	1909	19:40:59	19:40:00	14 OCT 05	19:40:30	90369
	1325	19:44:14	19:43:30	14 OCT 05	19:44:00	90945
	1326	19:46:24	19:46:00	14 OCT 05	19:46:30	90946
	2015	15:09:03	15:07:00	15 OCT 05	15:07:30	91178
	1908	15:10:52	15:09:30	15 OCT 05	15:10:00	91179
	1330	15:11:51	15:11:00	15 OCT 05	15:11:30	91179
SBE-37 SST	1305	00:00:21	00:00:00	13 OCT 05	00:00:30	90775
	1841	00:06:58	00:06:33	13 OCT 05	00:11:30	90777
XX-105	3704	17:30:14	17:26:30	13 OCT 05	NA	15010
	3837	17:28:40	17:33:30	13 OCT 05	NA	14961
	3762	17:47:10	17:41:00	13 OCT 05	NA	15010
	3203	18:07:02	18:03:00	13 OCT 05	NA	15010
	3258	18:01:04	18:05:15	13 OCT 05	NA	15011
	3836	18:19:07	18:14:30	13 OCT 05	NA	15011
	3830	18:17:03	18:19:30	13 OCT 05	NA	15011
	3831	18:32:37	18:25:00	13 OCT 05	NA	15012
XR-420-CT	10514	09:48:52	09:47:45	13 OCT 05	09:48:15	89K

VMCM	Serial Number	Clock	Time UTC	Stop sampling UTC	Records
	037	19:59:26, 15 OCT 05	19:45:00, 15 OCT 05	19:46:00, 15 OCT 05	449431
	038	09:46:41, 16 OCT 05	09:46:00, 16 OCT 05	09:47:00, 16 OCT 05	450298
	042	No Comms	Battery = 1.1v	NA	309495
	058	22:01:12, 16 OCT 05	21:53:00, 16 OCT 05	21:55:00., 16 OCT 05	451078
	032	12:20:06, 17 OCT 05	12:05:00, 17 OCT 05	12:06:00, 17:OCT 05	451942
	010	12:30:43, 17 OCT 05	12:29:00, 17 OCT 05	12:30:00, 17 OCT 05	451925
	075	12:51:26, 17 OCT 05	12:55:00, 17 OCT 05	12:56:00, 17 OCT 05	452168
RDI	1218	11:47:23, 13 OCT 05	11:47:00, 13 OCT 05	N/A	3024029
Sontek	D208	11:57:28, 13 OCT 05	11:57:30, 13 OCT 05	11:57:00, 13 OCT 05	1143914

Pre-cruise In port Check List

Project Name: Stratus 6

TASK

Note Primary 1 Logger Number: L-01

Note Primary 2 Logger Number: L-02

Note Primary 1 Module Numbers (Attach Form) Done

Note Primary 2 Module Numbers (Attach Form) Done

Start SST's (SBE-37's) to Internal Record Note start time/date UTC: 17:00:00, 3 OCT 05

Power Up Logger Primary 1 Note time/date UTC: 17:50:00, 3 OCT 05

Power Up Logger Primary 2 Note time/date UTC: 17:51:00, 3 OCT 05

Test Modules Primary 1 Done

Test Modules Primary 2 Done

Check/Set Logger Clock Primary 1 Note time/date UTC: 17:55:00, 3 OCT 05

Check/Set Logger Clock Primary 2 Note time/date UTC: 17:56:00, 3 OCT 05

Check/Set Module Clocks: Done

Zero Module FLASH Cards: Done

Zero Logger FLASH Card Primary 1 : Done

Zero Logger FLASH Card Primary 2 : Done

Buoy Spin (Attach Sheets) : Done (Woods Hole)

Record interval of Modules Primary 1 & 2: 1 Min.

Record interval of Loggers Primary 1 & 2 : 1 Min.

Record interval of SST's (SBE-37's) : 5 Min.

Logger 1 Start sampling Time/Date UTC: 17:59:00, 3 OCT 05

Logger 2 Start sampling Time/Date UTC: 17:58:00, 3 OCT 05

Test sub-surface PTT for transmit: Done
Subsurface AGROS transmitter: S/N=22, ID: 11427

General Notes:

SST's unplugged @ 19:45:00, 4 OCT 05

SST's plugged back in @ 20:25:00, 4 OCT 05

Stand alone HRH and LWR plugged into batteries and running @ 20:03:00, 3 OCT 05

APPENDIX E - IMET SETUP NOTES

SBE37-SM s/n: 1899
Firmware version: 2.5
RS-232 9600 Baud
Time set & checked
Records free: 233016
Format=1
Storetime=Y
Outputsal=N
OutputSV=N
Repress=0
Sample Interval=300 (seconds)
Samplenum=0 (pointer reset)
StartMMDDYY=093005
StartHHMMSS=010000
Startlater=OK

SBE37-SM s/n: 2011
Firmware version: 2.5
RS-232 9600 Baud
Time set & checked
Records free: 233016
Format=1
Storetime=Y
Outputsal=N
OutputSV=N
Repress=0
Sample Interval=300 (seconds)
Samplenum=0 (pointer reset)
StartMMDDYY=093005
StartHHMMSS=010000
Startlater=OK

SBE37-SM s/n: 1901
Firmware version: 2.5
RS-232 9600 Baud
Time set & checked
Records free: 233016
Format=1
Storetime=Y
Outputsal=N
OutputSV=N
Repress=0
Sample Interval=300 (seconds)
Samplenum=0 (pointer reset)
StartMMDDYY=093005
StartHHMMSS=010000
Startlater=OK

SBE37-SM s/n: 1905
Firmware version: 2.5
RS-232 9600 Baud
Time set & checked
Records free: 233016
Format=1
Storetime=Y
Outputsal=N
OutputSV=N
Refpress=0
Sample Interval=300 (seconds)
Samplenum=0 (pointer reset)
StartMMDDYY=093005
StartHHMMSS=010000
Startlater=OK

SBE37-SM s/n: 1912
Firmware version: 2.5
RS-232 9600 Baud
Includes Pressure
Time set & checked
Records free: 190650
Format=1
Storetime=Y
Outputsal=N
OutputSV=N
Refpress=0
Sample Interval=300 (seconds)
Samplenum=0 (pointer reset)
StartMMDDYY=093005
StartHHMMSS=010000
Startlater=OK

SBE37-SM s/n: 1902
Firmware version: 2.5
RS-232 9600 Baud
Time set & checked
Records free: 233016
Format=1
Storetime=Y
Outputsal=N
OutputSV=N
Refpress=0
Sample Interval=300 (seconds)
Samplenum=0 (pointer reset)
StartMMDDYY=093005
StartHHMMSS=010000
Startlater=OK

SBE37-SM s/n: 1903
Firmware version: 2.5
RS-232 9600 Baud
Time set & checked
Records free: 233016
Format=1
Storetime=Y
Outputsal=N
OutputSV=N
Repress=0
Sample Interval=300 (seconds)
Samplenum=0 (pointer reset)
StartMMDDYY=093005
StartHHMMSS=010000
Startlater=OK

SBE37-SM s/n: 1910
Firmware version: 2.5
RS-232 9600 Baud
Includes Pressure
Time set & checked
Records free: 190650
Format=1
Storetime=Y
Outputsal=N
OutputSV=N
Repress=0
Sample Interval=300 (seconds)
Samplenum=0 (pointer reset)
StartMMDDYY=093005
StartHHMMSS=010000
Startlater=OK

SBE39 s/n: 717
Firmware version: 1.7
RS-232 2400 Baud
Plastic SST
Time set & check
Zero Mem 299593 free
Start at 30Sep05 010000

SBE39 s/n: 716
Firmware version: 1.7
RS-232 9600 Baud
Plastic SST
Time set & check
Zero Mem 299593 free
Start at 30Sep05 010000

SBE39 s/n: 282
Firmware version: 1.7
RS-232 9600 Baud
Time set & check
Zero Mem 299593 free
Start at 30Sep05 010000

SBE39 s/n: 203
Firmware version: 1.7
RS-232 9600 Baud
Plastic SST
Time set & check
Zero Mem 299593 free
Start at 30Sep05 010000

SBE16 s/n: 927
Firmware version: 4.1b
Main battery: 10.5v
Lithium battery: 5.3v
Records free: 260821
Memory Test OK
Initialize Ram OK
Time Set & Checked
Sample Interval 300 sec
Start Time 30Sep05 010000
Logging Initialized
Go log OK

SBE16 s/n: 1877
Firmware version: 4.1b
Main battery: 10.5v
Lithium battery: 5.3v
Records free: 260821
Memory Test OK
Initialize Ram OK
Time Set & Checked
Sample Interval 300 sec
Start Time 30Sep05 010000
Logging Initialized
Go log OK

SBE16 s/n: 928
Firmware version: 4.1b
Main battery: 10.5v
Lithium battery: 5.3v
Records free: 260821
Memory Test OK
Initialize Ram OK
Time Set & Checked
Sample Interval 300 sec
Start Time 30Sep05 010000
Logging Initialized
Go log OK

SBE16 s/n: 994
Firmware version: 4.1b
Main battery: 10.5v
Lithium battery: 5.3v
Records free: 260821
Memory Test OK
Initialize Ram OK
Time Set & Checked
Sample Interval 300 sec
Start Time 30Sep05 010000
Logging Initialized
Go log OK

SBE16 s/n: 993
Firmware version: 4.1b
Main battery: 10.5v
Lithium battery: 5.3v
Records free: 260821
Memory Test OK
Initialize Ram OK
Time Set & Checked
Sample Interval 300 sec
Start Time 30Sep05 010000
Logging Initialized
Go log OK

SBE16 s/n: 146
Firmware version: 4.1b
Main battery: 10.5v
Lithium battery: 5.3v
Records free: 260821
Memory Test OK
Initialize Ram OK
Time Set & Checked
Sample Interval 300 sec
Start Time 30Sep05 010000
Logging Initialized
Go log OK

SeaBird Timing spikes

SBE37's in cold salt bucket at
30Sep05 13:21:00 GMT
SBE39's in cold salt bucket at
30Sep05 13:23:00 GMT
ALL out at 14:40:00
SBE16's in cold salt bucket at
30Sep05 15:12:00
Out at 16:08:00

Flux Measurement

Sensor center is 531cm from deck
Deck is 678cm from deck

2Oct05

Buoy shutdowns

Loggers off at 17:38:00 GMT 2Oct05

PRC505	2256 records used	clocked and zeroed
BPR221	1395 records used	clocked and zeroed
WND348	2996 records used	clocked and zeroed
HRH503	650 records used	clocked and zeroed
HRH208	1272 records used	clocked and zeroed
HRH221	1898 records used	clocked and zeroed
WND212	2320 records used	clocked and zeroed
BPR504	1802 records used	

Note: Clock on logger card was not running. Replaced logger card.
clocked and zeroed

PRC207 2284 records used

Note: Killed logger card by plugging in flash card while powered.
Replaced logger card with spare.

		clocked and zeroed
LWR221	961 records used	clocked and zeroed
SWR505	1899 records used	clocked and zeroed

3Oct05

LWR204	813 records used	clocked and zeroed
LWR506	716 records used	clocked and zeroed
SWR207	1297 records used	clocked and zeroed

SST SBE37 s/n 1834 v2.3a
29966 records used

RS-485 9600 Baud

Time set & checked

Format=1

Storetime=Y

Outputsal=N

OutputSV=N

Repress=0

Sample Interval=300 (seconds)

Samplenum=0 (pointer reset)

StartMMDDYY=100305

StartHHMMSS=170000

Startlater=OK

SST SBE37 s/n 1837 v2.3a
29975 records used
RS-485 9600 Baud
Time set & checked
Format=1
Storetime=Y
Outputsal=N
OutputSV=N
Repress=0
Sample Interval=300 (seconds)
Samplenum=0 (pointer reset)
StartMMDDYY=100305
StartHHMMSS=170000
Startlater=OK

Logger 1 records used 148057
Logger 2 records used 148103
Logger clocks set
Logger cards erased
Logger 1 kickoff at 17:59:00 utc 03Oct05
Logger 2 kickoff at 17:58:00 utc 03Oct05

Standalone HRH & LWR plugged in and running at 20:03:00 03Oct05

SST spikes
In salt spike at 14:05:00 utc 04Oct05
Add ice at 17:36:00 utc 04Oct05
Out at 19:25:00 utc 04Oct05
SSTs unplugged at 19:45:00 04Oct05
SSTs replaced at 20:25:00 04Oct05

Solar spikes
Bag solars at 17:46:00 utc 04Oct05
Unbag solars at 21:06:00 utc 04Oct05

Prc spikes
PRC fill and drain at 14:25:00 utc 04Oct05
Add water at 17:25:00 utc 04Oct05
Add water at 13:20:00 utc 06Oct05
PRC fill and drain at 16:12:00 utc 06Oct05

Long wave sensors
After reviewing data from the Stratus 5 mooring, the Stratus 6 mooring, and ETL all of the PIRs appear to agree very well with the exception of the Stratus 6 system 1 LWR. This sensor seems to read high by about 9 Wm⁻².

RECOVERY

Stratus 5
13Oct05
SBE37 SST s/n 1841 rs-485
GMT 00:06:33
SBE37 00:06:58
Stopped at 00:11:30
90777 samples used
142239 samples free
File given to Paul

Stratus 6
Wind vanes off
L1 16:06:00 utc 13Oct05
L2 16:07:00 utc 13Oct05
Wind vanes replaced
L1 17:07:00 utc 13Oct05
L2 17:10:00 utc 13Oct05

Stratus 5 Buoy
Precips cycled
System 1 17:21:00 utc 13Oct05
System 2 17:22:00 utc 13Oct05
Bag Solars 12:15:00 13Oct05
Unbag solars 17:24:00 13Oct05
SST temp spike in 19:12:00 12Oct05
SST temp spike out 20:04:00 12Oct05
Logger 1 (L-04) time check 13:13:50 13Oct05
Logger 1 utc comparison 13:13:02 13Oct05
Logger 2 (L-05) time check 13:17:07 13Oct05
Logger 2 utc comparison 13:16:12 13Oct05
Logger 1 Sampling stopped at 17:41:37 utc 13Oct05
Records used: 454915
Records free: 198397
Logger 2 Sampling stopped at 17:47:08 utc 13Oct05
Records used: 454924
Records free: 198388
Well opened at 18:07:00 utc 13Oct05
System 1 (L-04) powered down at 18:11:48 utc
System 2 (L-05) powered down at 18:12:38 utc
Humidity indicators on dessicant bomb all nice and blue

Stratus 5 modules

HRH216 – L1

Instrument clock: 19:56:45 13Oct05

UTC: 19:46:40 13Oct05

Number of records: 7584

HRH232 – L2

Instrument clock: 19:43:01 13Oct05

UTC: 19:36:10 13Oct05

Number of records: 389

BPR216 – L1

Instrument clock: 20:17:49 13Oct05

UTC: 20:11:10 13Oct05

Number of records: 7584

BPR217 – L2

Instrument clock: 19:17:31 13Oct05

UTC: 19:10:40 13Oct05

Number of records: 7584

WND221 – L1

Instrument clock: 20:02:21 13Oct05

UTC: 19:57:00 13Oct05

Number of records: 7579

WND225 – L2

Instrument clock: 19:28:56 13Oct05

UTC: 19:22:30 13Oct05

Number of records: 7578

PRC206 – L1

Instrument clock: 20:37:34 13Oct05

UTC: 20:21:50 13Oct05

Number of records: 7484

PRC205 – L2

Instrument clock: 19:06:28 13Oct05

UTC: 18:56:20 13Oct05

Number of records: 7584

LWR502 – L1

Instrument clock: 20:45:35 13Oct05

UTC: 20:43:00 13Oct05

Number of records: 7584

LWR218 – L2

Instrument clock: 21:11:05 13Oct05

UTC: 21:05:00 13Oct05

Number of records: 7584

SWR219 – L1

Instrument clock: 20:38:20 13Oct05

UTC: 20:32:31 13Oct05

Number of records: 7577

SWR209 – L2

Instrument clock: 21:04:42 13Oct05

UTC: 20:55:40 13Oct05

Number of records: 7575

Radiometers:

A quick comparison of 12 hours of LW radiometer data from 2 ETL sensors, the 2 Stratus 5 LWRs and 2 of the Stratus 6 LWRs showed good agreement with all but one of the Stratus 6 units. Differences between the 5 'good' units averaged about 3 watts. The 6th unit was about 9 watts higher than the average of the other 5.

I also conducted a brief test to see if cycling the power to a long wave module, caused a shift in the electronics. The test was run over a period of three and one half days. After initial power-up, the supplies to both LWRs were cycled twice. The data was then dumped and analyzed. There was no shift in the total longwave value discernable following a power interruption.

Two periods of data taken from the 1 minute logger record were also plotted against the LW sensors fielded by Chris Fairall. This was done to compare the Stratus 5 units upon deployment as well as recovery to check their agreement as well as look for drift over the 10 month deployment. On deployment the ASIMET LWRs agreed to within 0 to -2 watts. On recovery, the agreement was almost perfect.

The Sonic system on the bowmast was shut down early on 20Oct05. The files were copied onto two cds. The cd labels are Stratus_05a and Stratus_05b.

REPORT DOCUMENTATION PAGE	1. REPORT NO. WHOI-2006-06	2. UOP-2006-01	3. Recipient's Accession No.
4. Title and Subtitle Stratus Ocean Reference Station (20°S, 85°W), Mooring Recovery and Deployment Cruise R/V <i>Ronald H. Brown</i> Cruise 05-05, September 26, 2005–October 21, 2005		5. Report Date February 2006	
7. Author(s) Lara Hutto, Robert Weller, Jeff Lord, Jason Smith, Paul Bouchard, Chris Fairall, Sergio Pezoa, Ludovic Bariteau, Jessica Lundquist, Virendra Ghate, Rodrigo Castro, Carolina Cisternas		6.	
9. Performing Organization Name and Address Woods Hole Oceanographic Institution Woods Hole, Massachusetts 02543		8. Performing Organization Rept. No.	
12. Sponsoring Organization Name and Address National Oceanic and Atmospheric Administration and the Cooperative Institute for Climate and Ocean Research		10. Project/Task/Work Unit No.	
		11. Contract(C) or Grant(G) No. (C) NA17RJ1223 (G)	
		13. Type of Report & Period Covered Technical Report	
15. Supplementary Notes This report should be cited as: Woods Hole Oceanog. Inst. Tech. Rept., WHOI-2006-06.		14.	
16. Abstract (Limit: 200 words) The Ocean Reference Station at 20°S, 85°W under the stratus clouds west of northern Chile is being maintained to provide ongoing, climate-quality records of surface meteorology, of air-sea fluxes of heat, freshwater, and momentum, and of upper ocean temperature, salinity, and velocity variability. The Stratus Ocean Reference Station (ORS Stratus) is supported by the National Oceanic and Atmospheric Administration's (NOAA) Climate Observation Program. It is recovered and redeployed annually, with cruises that have come between October and December. During the October 2005 cruise of NOAA's R/V <i>Ronald H. Brown</i> to the ORS Stratus site, the primary activities were recovery of the WHOI surface mooring that had been deployed in December 2004, deployment of a new WHOI surface mooring at that site, in-situ calibration of the buoy meteorological sensors by comparison with instrumentation put on board by staff of the NOAA Environmental Technology Laboratory (ETL), and observations of the stratus clouds and lower atmosphere by NOAA ETL. The ORS Stratus buoys are equipped with two Improved Meteorological (IMET) systems, which provide surface wind speed and direction, air temperature, relative humidity, barometric pressure, incoming shortwave radiation, incoming longwave radiation, precipitation rate, and sea surface temperature. The IMET data are made available in near real time using satellite telemetry. The mooring line carries instruments to measure ocean salinity, temperature, and currents. The ETL instrumentation used during the 2005 cruise included cloud radar, radiosonde balloons, and sensors for mean and turbulent surface meteorology. In addition, two technicians from the University of Concepcion collected water samples for chemical analysis. Finally, the cruise hosted a teacher participating in NOAA's Teacher at Sea Program.			
17. Document Analysis a. Descriptors stratus ocean climate b. Identifiers/Open-Ended Terms c. COSATI Field/Group			
18. Availability Statement Approved for public release; distribution unlimited.		19. Security Class (This Report) UNCLASSIFIED	21. No. of Pages 143
		20. Security Class (This Page)	22. Price